

# OUR STRENGTH

## PRODUCTS

Valves	Isolation Kits, Gaskets, Studs & Bolts
Reactors and Columns	Pipes, Fittings & Flanges
Instrumentation Valves	Strainers
Corrosion Monitoring System	Heat Exchangers / Pressure Vessels
Branch Fittings (Olets and Flangelets)	Expansion Joints / Bellows
Orifice Plates, Orifice flange	Potable Water Valves and pumps
CPVC Fittings, valves, strainers	Spectacle blinds and Spades
Axial Control Valve, Axial HIPPS, Isolation and Choke Valves	Chemical Injection System

## SPECIALIZED SERVICES

- 1 HOT TAPPING AND LINE STOPPLE
- 2 UNDER PRESSURE LEAK SEALING
- 3 ONLINE SAFETY RELIEF VALVE TESTING
- 4 ONSITE MACHNING
- 5 PASSIVE FIRE PROTECTION
- 6 ONLINE RETRIEVAL AND COROSSION MONITORING
- 7 ONLINE VALVE MAINTENANCE
- 8 PIPE FREEZING

# VALVES DIVISION

## GATE VALVE

**Purpose:** Gate valve used for pipeline isolation purpose in oil & gas, water segment

**Application:** Hydro carbon, Steam, LNG, LPG, Water

**Size Range:** 1/2" ~ 60"

**Class Rating:** 150CL ~ 4500CL

**Material Grade:** WCB, WCC, A105, LCB, LCC, LF2, WC6, WC9, C5, C12, F11, F22, CA15, CA6NM, CF8M, CF8, CF3M, CF3 Duplex stainless steel, Super duplex stainless steel, Nickel alloys, Copper alloys.

**Technical Specification:**

- Wedge type design, Parallel slide design
- Extended stem design, Pressure seal bonnet design, Bolted Bonnet, Extended bonnet for cryogenic application, Gate valve with Bypass valve for high pressure service
- Motor operated valve, Flanged/buttweld end/threaded/ socket weld end
- Forged steel/Cast steel gate valve
- API600/API602/API 603/API 6A Valves

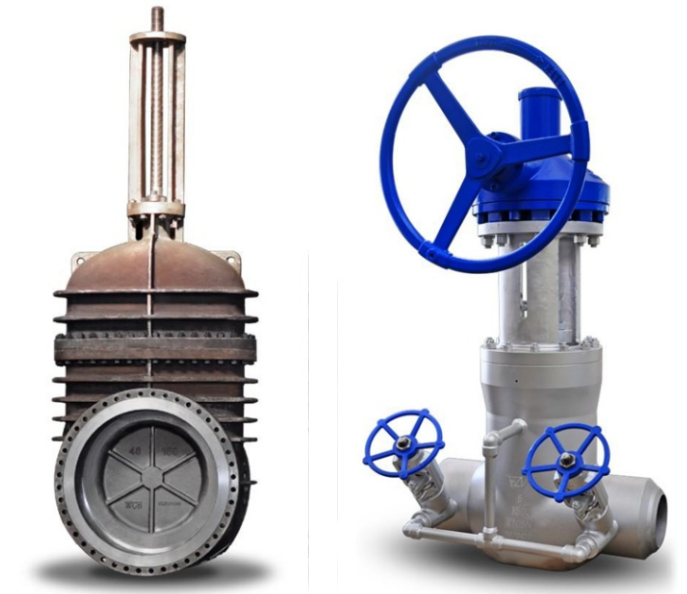

## GLOBE VALVE

**Purpose:** Globe valve used for throttling purpose in oil & gas, water industry.

**Application:** Hydro carbon, Steam, LNG, LPG, Water

**Size Range:** 1/2" ~ 24"

**Class Rating:** 150CL ~ 4500CL

**Material Grade:** : WCB, WCC, A105, LCB, LCC, LF2, WC6, WC9, C5, C12, F11, F22, CA15, CA6NM, CF8M, CF8, CF3M, CF3 Duplex stainless steel, Super duplex stainless steel, Nickel alloys, Copper alloys.

**Technical Specification:**

- Plug type design/Ball type design
- Pressure seal bonnet design
- Extended bonnet for cryogenic application
- Motor operated valve
- Forged steel/cast steel globe valve
- Flanged/buttweld end/threaded/socket weld end

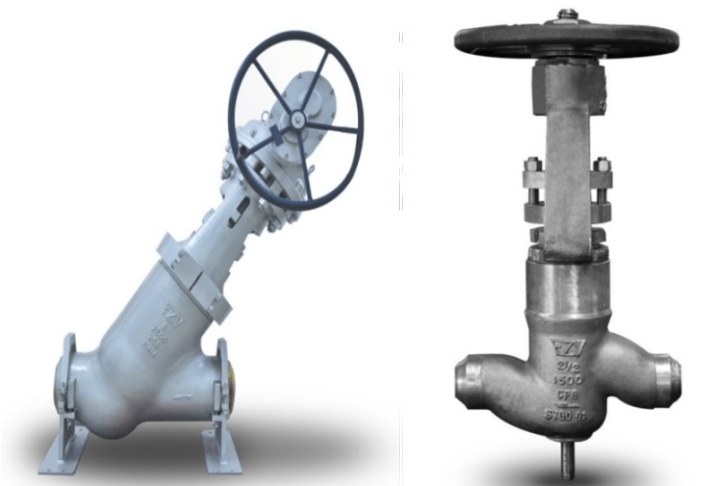

## VALVES DIVISION

### CHECK VALVE

**Purpose:** Check valve used in oil & gas, water segment to arrest the reverse motion of fluid which affects the pump and compressor.

**Application:** Hydro carbon, Steam, LNG, LPG, Water

**Size Range:** 1/2" ~ 60"

**Class Rating:** 150CL ~ 4500CL

**Material Grade:** WCB, WCC, A105, LCB, LCC, LF2, WC6, WC9, C5, C12, F11, F22, CA15, CA6NM, CF8M, CF8, CF3M, CF3 Duplex stainless steel, Super duplex stainless steel, Nickel alloys, Copper alloys.

**Technical Specification:**

- Swing check valve, Dual Plate check valve, Axial flow check valve, Piston Check Valve, ball Check valve, water Check valve, Tilting Disc Check valve.
- Pressure seal bonnet design, Bolted bonnet, Welded type.
- Forged steel/Cast steel check valve
- Flanged/buttweld end/threaded/socket weld end

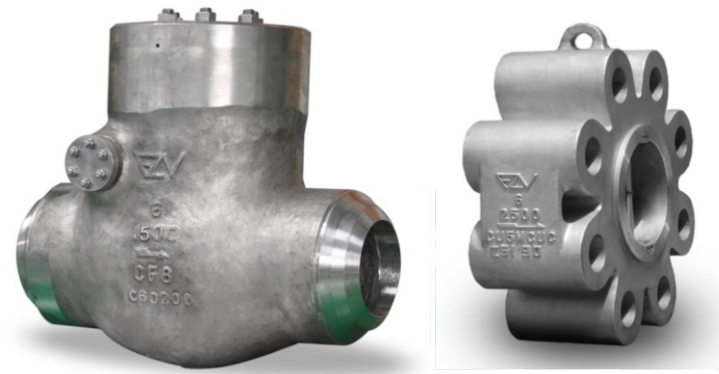

### BALL VALVE

**Purpose:** Ball valve is quarter turn valve used in oil & gas, water segment for isolation purpose.

**Application:** Hydro carbon, Steam, LNG, LPG, Water

**Size Range:** 1/2" ~ 48"

**Class Rating:** 150CL ~ 4500CL

**Material Grade:** WCB, WCC, A105, LCB, LCC, LF2, WC6, WC9, C5, C12, F11, F22, CA15, CA6NM, CF8M, CF8, CF3M, CF3 Duplex stainless steel, Super duplex stainless steel, Nickel alloys, Copper alloys.

**Technical Specification:**

- Floating ball valve design
- Tunnion mounted ball valve design
- Extended spindle for buried application
- Metal seated ball valve
- Soft seated ball valve
- Top entry ball valves
- Fully weld construction
- Single piece/two piece/three piece construction

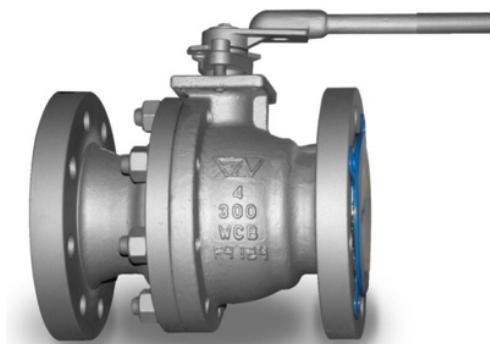

## VALVES DIVISION

### BUTTERFLY VALVE

**Purpose:** Butterfly valve is used in oil & gas, water segment for isolation and throttling purpose.

**Application:** Hydro carbon, Steam, LNG, LPG, Water

**Size Range:** 1/2" ~ 120"

**Class Rating:** 150CL ~ 4500CL

**Material Grade:** WCB, WCC, A105, LCB, LCC, LF2, WC6, WC9, C5, C12, F11, F22, CA15, CA6NM, CF8M, CF8, CF3M, CF3 Duplex stainless steel, Super duplex stainless steel, Nickel alloys, Copper alloys.

**Technical Specification:**

- Soft seated and Metal seated construction
- Concentric, double offset, triple offset design
- Extended stem design
- Motor operated valve



### CONTROL VALVE

**Purpose:** Control valves is used in oil & gas, water segment to control the process by controlling the fluid in the process.

**Application:** Hydro carbon, Steam, LNG, LPG, Water

**Size Range:** 1/2" ~ 24"

**Class Rating:** 150CL ~ 4500CL

**Material Grade:** : WCB, WCC, A105, LCB, LCC, LF2, WC6, WC9, C5, C12, F11, F22, CA15, CA6NM, CF8M, CF8, CF3M, CF3 Duplex stainless steel, Super duplex stainless steel, Nickel alloys, Copper alloys.

**Technical Specification:**

- Control valves for severe duty application
- Linear motion valves-Globe, Diaphragm or pinch type
- Rotary motion valve-Ball, Butterfly, Plug type



# VALVES DIVISION

## INSTRUMENTATION VALVE

**Purpose:** Instrumentation valve is used in oil & gas, water segment to assist temperature and pressure gauge, sampling of process fluid etc.

**Application:** Hydro carbon, Steam, LNG, LPG, Water

**Size Range:** 1/2" ~ 6"

**Class Rating:** 150CL ~ 4500CL

**Material Grade:** WCB, WCC, A105, LCB, LCC, LF2, WC6, WC9, C5, C12, F11, F22, CA15, CA6NM, CF8M, CF8, CF3M, CF3 Duplex stainless steel, Super duplex stainless steel, Nickel alloys, Copper alloys.

**Technical Specification:**

- Single block and bleed type
- Double block and bleed type
- Monoflange type
- Modular type design
- Sampling valve
- Chemical injection valve
- Needle valve
- Manifold valve



## DOUBLE BLOCK AND BLEED (DBB) PIPELINE BALL VALVE

1/2 to 10" Soft and Metal Seated

API 10000 PSI, Floating & Trunnion Mounted Design

**Pressure Class Rating:** 150 to 2500 according to ASME, API & DIN Standard

**Material Grade:** CS, SS, DSS, SDSS, Alloy 625, 825, Monel & Hastelloy.



# VALVES DIVISION

## AXIAL CONTROL & CHOKE VALVES

**Purpose:** Axial control valves are used in highly demanding application where tight shut off, high reliability and fast opening/Closing and precise control are desired.

**Application:** Hydro carbon, energy, and process industries, Axial control valves are used in a diversity of liquid, gas and multi-phase fluid application.

**Size Range:** 2" ~ 48"

**Class Rating:** 150CL ~ 2500CL, API 3000PSI - 15000 PSI

**Material Grade:** Carbon steel, Stainless steel, Dupex, Super Duplex, low-high Alloy, Nickel alloy, Titanium alloy.

**Technical Specification:**

- Sever Service application.
- Critical service
- Anti-surge application
- Recycle control
- Pressure let down
- Noise attenuation
- Anti-cavitation

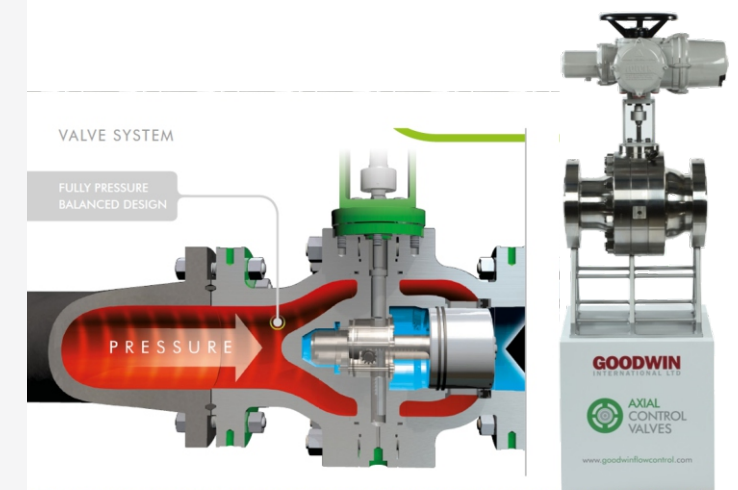

## AXIAL ISOLATION & HIPPS VALVES

**Purpose:** Axial Isolation valve are used in highly demanding application where tight shut off, high reliability and fast opening/Closing are desired.

**Application:** Hydro carbon, energy, and process industries, Axial isolation valves are used in a diversity of liquid, gas and multi-phase fluid application.

**Size Range:** 2" ~ 48"

**Class Rating:** 150CL ~ 2500CL, API 3000PSI - 15000 PSI

**Material Grade:** Carbon steel, Stainless steel, Dupex, Super Duplex, low-high Alloy, Nickel alloy, Titanium alloy .

**Technical Specification:**

- Emergency shutdown(ESD)
- Safety shutoff
- Over pressure protection (HIPPS)

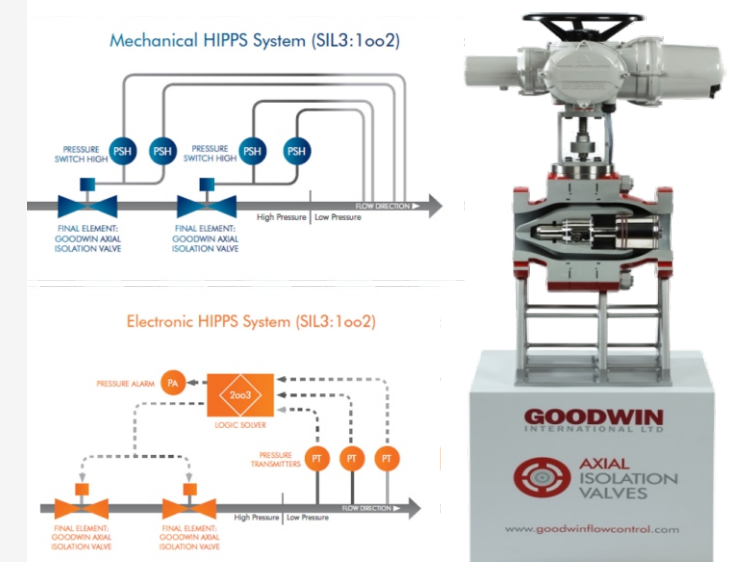

# PIPELINE PRODUCTS & EQUIPMENT DIVISION

## HOT TAP AND LINE STOP TEES

**Purpose:** Hot tap and Line Stop Tees are used in Pipeline intervention jobs enabling to safely carry out repair / modification / tie in works in a pressurized system, without a shut down.

**Types:** Extruded and Fabricated fittings

**Mating type:** Welded or Mechanical Fittings

**Material Grades:** Carbon Steel, Stainless Steel, High yield stress materials

**Pressure Class:** All Pressure classes including ANSI and PN standards

**Standards:** Tees are generally designed to meet ASME B31.3 and B31.4/8 with 0.72 design factor. Customized design parameters possible

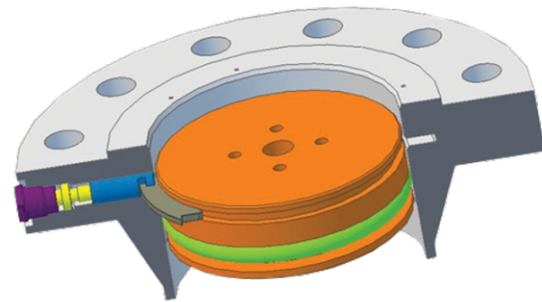
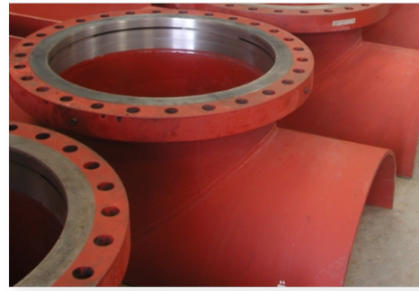

## CORROSION MONITORING SYSTEMS

### A) CHEMICAL INJECTION ASSEMBLIES / SAMPLING SYSTEMS

**Purpose:** Injection system is used to inject a wide range of chemicals into the process pipeline. This allows for even distribution of the injected fluid into the process medium.

**Sampling systems** are used to take samples of the process fluid or medium for further analysis by client.

**Models:** High pressure Flanged and Flare weld design, Fixed flange design, Retractable design

**Material Grades:** All material grades including CS/SS/DSS/SDSS/I 625/ I 825 are available

**Quill End types:** Open Quill (with and without chamfer), Nozzle, Atomizer - Cap and Core type

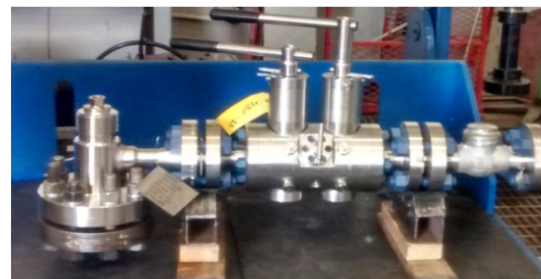
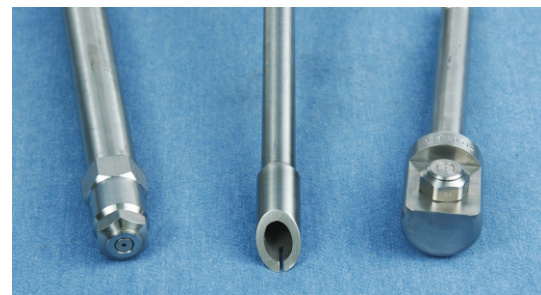
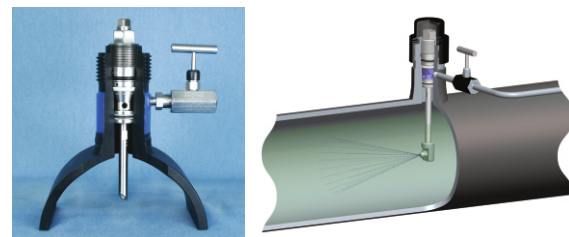

# PIPELINE PRODUCTS & EQUIPMENT DIVISION

## CORROSION MONITORING SYSTEMS

### B) CORROSION PROBE ASSEMBLIES

**Purpose:** Probe assemblies are generally used where on-line corrosion rate readings are required. The corrosion rate can be determined without the removal of probe from the system.

**Models:** High pressure Flanged and Flare weld design, Retractable design

**Types:** Electric Resistance probes, LPR Probes (for conductive medium), Sand Probes

**Probe end models:** Wire Loop Probes, Flush Design, Cylindrical probes, tube loop

**Material Grades:** Customized material grades possible for Probe body and element

**Measurement:** Online readings are obtained with a hand held Data Logger, Remote Data Logger, High resolution transmitters etc.

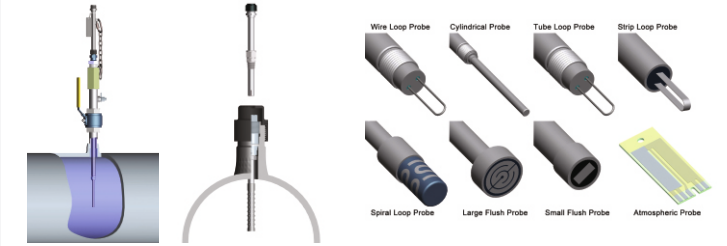

## CORROSION MONITORING SYSTEMS

### C) CORROSION COUPON ASSEMBLIES

**Purpose:** Corrosion coupons are an accurate means of monitoring of corrosion rate by carrying the weight loss analysis of the exposed coupon, and calculating the corrosion rate of the coupon, over the exposed period.

Corrosion coupons are periodically retrieved from the system online, by using a Retrieval Tool and Service Valve.

**Models:** High pressure Flanged and Flare weld design, Retractable design

**Coupon models:** Flat Strip, Flush Disc, Cylindrical, Welded, Ladder etc.

**Material Grades:** Customized material grades possible for Coupons

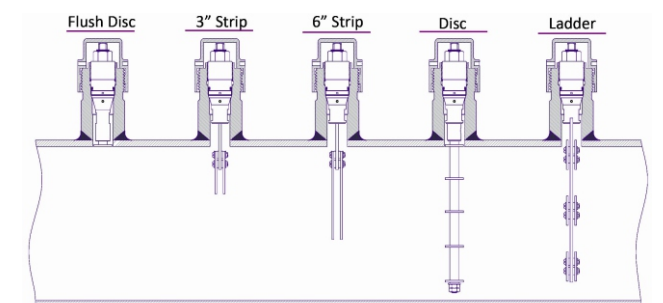

## PIPELINE PRODUCTS & EQUIPMENT DIVISION

### EXPANSION JOINTS / BELLOWS

#### a) Fabric Expansion Joints

- Series of standard types of Fabric Expansion Joints along with numerous special designs.
- Custom made Fabric Expansion Joints are also available in all sizes and shapes for any application.
- Available from single bellows for ventilating systems to highly advanced multilayer expansion joints for gas turbine exhaust.
- There are 26 standard types divided into five categories.
- The temperature capability ranges from - 50°C to 1000°C and the pressure ranges from - 50 kPa to 50 kPa.



### EXPANSION JOINTS / BELLOWS

#### b) Elastomere Expansion Joints

- Suitable for continuous temperatures up to 200°C.
- The Elastomere Expansion Joints are available in numerous shapes and sizes, but four elastomer products represent the standard range.
  - PTFE polytetrafluoroethylene
  - EPDM ethylene propylene diene terpolymer
  - FKM fluorocarbon elastomer (Viton B)
  - SI silicone rubber



## PIPELINE PRODUCTS & EQUIPMENT DIVISION

### EXPANSION JOINTS / BELLOWS

#### c) Metal Expansion Joints

- This covers any application where Fabric and Elastomere Expansion Joints are not suitable, mainly due to pressure conditions.
- Designed according to either EN14917, EN13445 or EJMA.
- Standard designs are Axial, Lateral, Angular and Universal Expansion Joints, in materials of stainless steel or Titanium.
- Manufactured as single or multiple bellows and can be combined into double expansion joints.



### FILTERS / COALESCERS / FLAME ARRESTERS

#### Cast and Fabricated units with a scope of supply:

- Y-TYPE STRAINERS
- INLINE BASKET STRAINERS
- BATH-TUB & T-TYPE STRAINERS
- DUPLEX STRAINERS
- ANGLE TYPE STRAINERS
- BACK FLUSHING STRAINERS (Manual & Automatic)
- AIR FILTERS
- GAS FILTERS
- FLAME ARRESTERS (Inline & End-of-Line)

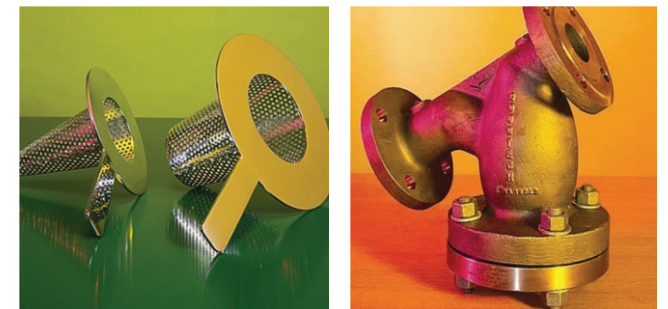

## PIPELINE PRODUCTS & EQUIPMENT DIVISION

### HEAT EXCHANGERS

- Specialised in **HIGH PRESSURE HEAT EXCHANGERS**
- Well experienced in fields of construction and calculation methods, like those associated with the manufacture of **RODBAFFLE HEAT EXCHANGERS**.
- Holds the Phillips license, and manufacturing techniques required for **INTERNAL BORE WELDING** of tube to tube sheets joints.
- Supply in off-shore industry too - **TITANIUM HEAT EXCHANGERS**.



### PROCESS EQUIPMENTS

- Specialised in high performance equipments like: **AMMONIA CONVERTER, AMMONIA SECONDARY REFORMER, CARBAMATE CONDENSER and WASTE HEAT BOILER**.
- Specialised in manufacturing of **UREA STRIPPERS & UREA REACTORS**.



## PIPELINE PRODUCTS & EQUIPMENT DIVISION

### REACTORS

- Specialised in **HIGH PRESSURE REACTORS**
- We ensure the highest quality and standards of manufacturing, with a heat treatment furnace and linear accelerator enabling strict in house control.
- Also experienced in manufacturing of **FCC REACTORS** and **PLATFORMING REACTORS**.



### PRESSURE VESSELS

- High pressure test Separators, Slug catchers, Clad vessel are in scope of supply.
- Specialised in fabrication using clad plate.
- Pressure vessels can be made to diameters as per client's needs, even beyond 5 meters, the final assembly being done in dedicated areas which has a closer access to a main sea port.



## PIPING PRODUCTS DIVISION

### FITTINGS

Wrought carbon steel and alloy steel fittings of seamless and welded construction covered by the latest revision are for use in pressure piping and in pressure vessel fabrication for service at moderate and elevated temperatures.

#### Products

- LR & SR Elbows, Equal Tee, Reducing Tee, Concentric & Eccentric Reducers, Caps, Laterals, Bends.
- Size 1/2" to 72" Size in Various Schedules and Material Grades in Seamless and Welded Construction.

#### Specification And Grades

- ANSI B16.9, MSS SP-75, MSS SP-97
- ASTM/ASME/SA234 Grade WPB /420 Grade WPL6  
MSS SP-75/ASTM/ASME A/SA860 WPHY52, 60 & 65  
ASTM/ASME A/SA 403 WP304/304L, WP 316/316L /
- UNS S31803 / UNS S32750 / S32760 /UNS S31254 / Alloy 400, 625, 800 & 825

### FLANGES

Flanges are used as a connection profile in Pipeline and associated equipment to provide means of assembling and disassembling components. Most flanges in Oil and Gas Industry feature a bolt-hole pattern to allow the joint to be secured and a gasket profile to ensure a pressure tight seal. The design and specification of a flange relates to the size and pressure capacity of the equipment to which it is fitted.

#### Products

- Weld neck, Blind, Slip On, Socket weld, Threaded Blind, Orifice Flanges, Spades, Spacers & Spectacle.
- 1/8" to 48" Size in Various Schedules and Material Grades with FF, RF and RTJ Facings.
- 150, 300, 600, 900, 1500 and 2500 pressure rating.

#### Specification And Grades

- ANSI B16.5, ANSI B16.47 Ser. A and B(MSS SP-44), API 6056A/6BX
- ASTM/ASME A/SA 105N / A/SA 350 LF2 CL 1/2 / 694 F52
- ASTM/ASME A/SA 516 Grade 65/70
- ASTM/ASME A/SA 182 F316/316L / 304 /304 L
- Duplex /Super Duplex ASTM A182 F51 / F53 / F55 / F44  
Alloy 400, 625, 800 & 825  
ASTM A694 6 F52, F60, F65 & F70



## PIPING PRODUCTS DIVISION

### PIPES

Pipes can be made from several alloys and metals such as carbon steel, stainless steel, Duplex etc. We supply a wide range of Pipes from small quantities to large scale projects which require several kilometers & tonnes of pipes.

#### Products

- 1/4" to 48" ODs in Various Schedules and Material Grades in Seamless and Welded Construction in SRL and DRL Lengths.
- Schedule walls ranging from 3mm to 100mm.

#### Specification And Grades

- ASTM / ASME A /SA106 Grade B /A53 Grade B /A333 Grade 6/API 5L B, X42, X52
- ASTM/ASME A/SA312 TP304/304L, TP316/316L
- S31803/S32750, S32750, S32760

### ISOLATION KITS

Flange Isolation Kits are used in critical and extreme application to avoid corrosion. Flange Isolation Kits are designed to work in conjunction with isolating gaskets to effect the complete electrical isolation of a flanged assembly.

#### Products

- Defender / Defender FS / Defender RG / Iso Guard / IsoMate.
- 1/2" to 48" Size in Various Schedules and Material Grades used for Flange Facing with FF, RF and RTJ Facings.
- 150 - 2500 pressure rating.

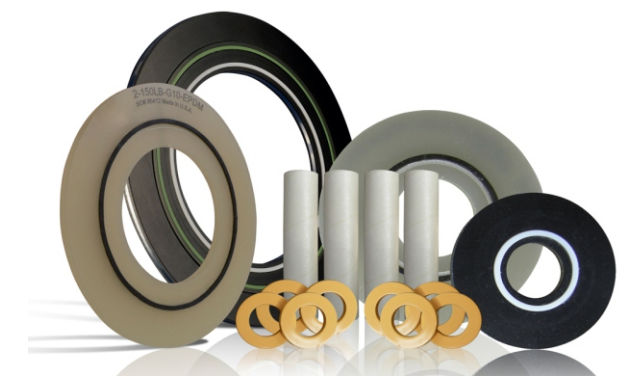

## PIPING PRODUCTS DIVISION

### STUDBOLTS AND GASKETS

A Gasket is a Mechanical Seal which fills the space between two or more mating flange surfaces, generally to prevent leakage from or into the joined objects while under compression and Studbolts are used to hold this Assembly.

#### Products

- Supplier of SPW Gaskets, Tanged Insert Gaskets, Ring Jount Gaskets, Metal Jacketed Gaskets, Kamprofile.
- High Tensile Fasteners, Blind Rivets, Anchor Bolts, Threaded Rods, Type J and Type L, U Bolts and Stud Bolts, Hex Head Bolts, Foundation Bolts, Jack Screw
- Hot Dip Galvanizing and Fluoropolymer coated could be supplied.

#### Specification And Grades

- ASTM A 193 Grade B7,B7M ,B8, B8M & B16 / ASTM A 320 Grade L7 & L7M
- Stainless Steel 304, 304L, 316, 316L, A2 - 70/80, A4 - 70/80 BS 3692 / BS 4190 grade 4.6, 4.8, 5.6, 5.8, 8.8, 10.9 and 12.9



### THERMOWELL

Thermowells are tubular fittings used to protect temperature sensors installed in industrial processes. A Thermowell consists of a tube closed at one end and mounted in the process stream.

#### Products

- Types: Flanged type / screwed type / weld-in.
- Size: 1/2" - 2", larger sizes on request.
- Rating: Class 150 lbs - 2500 lbs RF / RTJ.

#### Specification And Grades

- **Material:** Stainless steel (ASTM A182 F304 / F316L / F321) Duplex, monel, hastelloy etc.
- **Design as per:** Shell drawing S 38.100 / S 38.110 / S 38.103 / S 38.104 / S 38.113 / S 38.114 / client specification



## PIPING PRODUCTS DIVISION

### THREADED FITTINGS (FORGED)

#### Products

- 1/8" ~ 4"
- Elbow 90 Degree, Elbow 45 Degree, Tee, Cross, Union, Coupling, Half Coupling, Reducing Coupling, Cap, Hex Head Bushing, Hex Head Plug, Square Head Plug, Round Head Plug, Bull Plug, Hex Nipple, Swage Nipple

#### Specification And Grades

- ASME 16.11, MSS SP-79, 97, BS 3799
- ASTM/ASME A/SA105N / SA350 LF2 CL1/2 /SA694 F52 /SA 182 F304/304L, F316/316L



### BRANCH FITTINGS

#### Products

- Size : 1/2" to 48" - ANSI 3000, 6000, 9000 lb and in a whole range of schedules.
- Socket-Weld, Butt-Weld, Threaded Nipple, Elbow & Lateral Swept Radial Outlet, Insert Outlet, the Lightweight Outlet, Branch Vessel Insert Connections.

#### Specification And Grades

- In Accordance with MSSSP 97
- Carbon Steel / Stainless Steel ASTM A182 F304L / F316L / F321 Duplex Stainless Steel to UNS S31803 (ASTM A182 F51) Super Duplex Stainless Steel (to UNS 32760 and UNS 32750) Alloy Steels (ASTM A182 F5 / F9 / F11 / F22)





## PIPELINE SERVICES

### HOT TAPPING AND LINE STOPPING

Hot tapping is a technology that enables to safely, efficiently, and cost effectively tap into a pipeline under pressurized and operating conditions to make a connection to the main pipeline, without a shutdown and with minimal disruption to product flow.

Line stopping is a technology for modifying the existing pressurized system while it's under full operating conditions, by temporarily shutting down a portion of pipeline, and allowing bypass without disturbing the pipeline flow, with specialized equipments and arrangements.

**Equipment:** Hot tapping equipments with capacity upto 84" tapping and Line Stopping equipment with capacity upto 48".

Designed for carrying out jobs for all pressure ratings and into a wide variety of medium such as hydrocarbon, natural gas, water, steam and heavy oil.

**Personnel:** Job is carried out by Highly skilled and experienced personnel, who follow standard practices and approved job specific procedures and methods.



### ON - SITE MACHINING

**Purpose:** On-site machining services provide Portable Machine tools and Trained field service staff to meet the plant maintenance requirements calling for in-situ machining services.

#### Applications include

- Flange Facing
- Line Boring
- Journal turning
- Weld Prepping
- Drilling
- Pipe cutting
- Keyway cutting
- Casing cutting
- Milling
- Manway doors



## PIPELINE SERVICES

### UNDER PRESSURE LEAK SEALING

**Purpose:** Under Pressure Leak Sealing is a fully comprehensive service for the repair of leaking pipeline and pressure vessel systems, without the need to shut down the plant. Choice of sealant material depends on the line content, temperature and pressure of the system.

**Pipeline Medium:** Pipeline contents include water, steam, hydrocarbons and numerous chemical

Workable Pressure / temperature range:

Pressure (from vacuum to 400 bar) / Temperature (-60°C to 600°C)

**Common Types of leak repair:** Flanges Joints, Heat Exchanger Joints, Turbine joints, Corroded pipelines, Screwed couplings.



### PIPE FREEZING

**Purpose:** Pipe freezing is a fast, low cost, low risk method for isolation of a pipeline to enable maintenance operations, by controlled formation of ice plug inside the pipeline, using specialist equipment and techniques.

**Method:** Pipe Freezing involves using jackets fitted around the pipeline on either one or both sides of the work section, and introducing liquid nitrogen into the jacket to freeze the contents of the pipeline, thereby providing an isolation.

**Sectors:** Used in Power Generation, Oil and Gas, Refineries, Petrochemical industries.



## PIPELINE SERVICES

### UNITEST (Online Safety and Relief Valve Testing)

**Purpose:** Unitest allows to certify plant Safety and Relief Valves, while allowing plant to continue operating under normal conditions, thus eliminating the need to remove these valves for unnecessary overhauling / repairs.

**Principle:** The principle of operation is to apply force to the valve spindle to overcome the spring tension of the valve, using a hydraulic power pack in conjunction with an electronic force transducer, linked to a digital recorder that controls and records the force applied.

#### Verification parameters of Safety and Relief valve:

- Set pressure
- Reseat Pressure
- Spring rate
- Valve Displacement

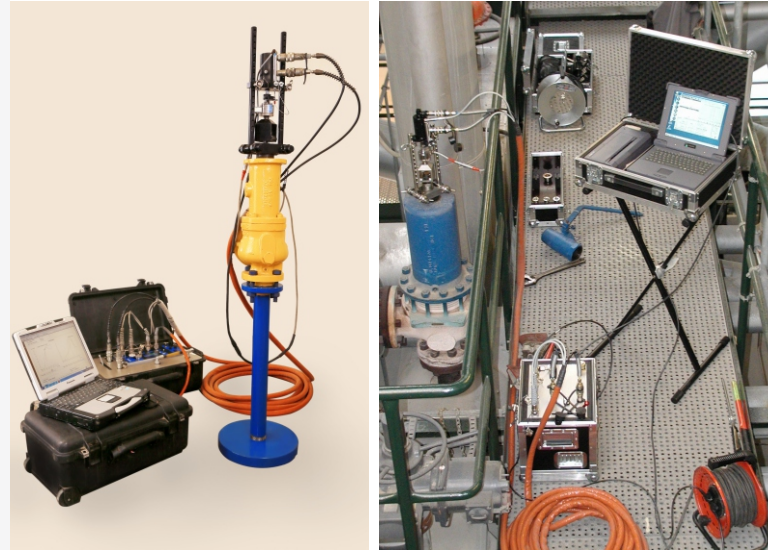

### ONLINE VALVE MAINTENANCE

**Purpose:** This method is used for online flushing of valves to remove old lubricant / sealant and hydrocarbon deposits followed by injection of specially formulated lubricants to enhance and protect the valves.

#### Scope includes :

- Flushing, Lubrication and Sealing of passing valves
- Equipment Sale or rental
- Training for valve maintenance
- Sale of Valve Liquid Flush, Lubricants and Sealants
- Sale of Valve Grease fittings
- Sale of valve lubrication adaptor kits



## PIPELINE SERVICES

### PASSIVE FIRE PROTECTION

- Supply and Application of Passive Fire Proofing system on Structural steel, including main structure / Pipe Racks and supports / Vessel skirts etc.
- Product is chosen with respect to services and the type of Fire expected - Jet Fire / Pool Fire etc.
- The products are applied on basis of UL standards to meet the desired fire rating of the project.
- Trained Personnel are involved in the application of the product as described in the respective product data sheets.



### ONLINE CORROSION MONITORING - RETRIEVAL SERVICES

**Description:** This method is used for online Retrieval and Reinstatement of corrosion monitoring Coupons / Probes or Chemical Injection assemblies under pressure, without a shut down .

#### Uses:

**Coupon assembly:** Retrieval of coupons and further weight loss analysis to determine the corrosion rate within the pipeline. Reinstatement of new coupons into the pipeline.

**Corrosion Probe / Quill Assembly:** Retrieval for replacement or for general routine check to determine the condition of installed probes or quills.

**Tools:** Specially designed Retrieval Tool and Service valve, pressure tested to 6000 psi and for an operating pressure of 3600 psi. Retrieval tool is available in varying stroke lengths, to suit various pipeline sizes and type of monitoring system .

**Personnel:** Job is carried out by Highly skilled and experienced personnel, who follow standard practices and execution procedures.

