



**FIRE STOPPING & COMPARTMENTATION SYSTEMS**

# **Technical Handbook:**

## **Fire Stopping Compartmentation Systems**

# FSi DEVELOP MANUFACTURE PROTECT

FIRE STOPPING & COMPARTMENTATION SYSTEMS

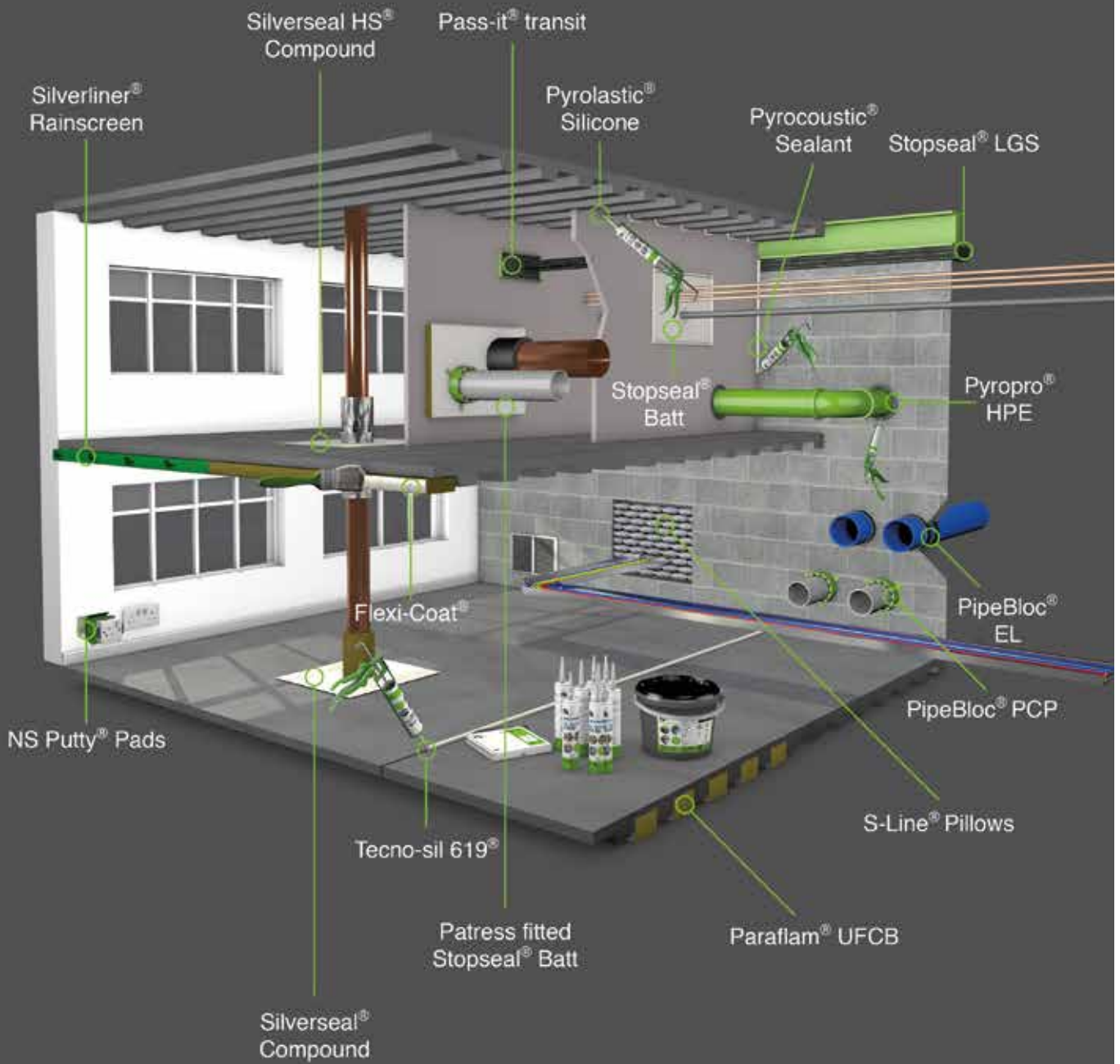

FSi manufacture and develop a full range of Built-In Fire Protection Systems to protect infrastructure and assets around the world. Key here is the reference to systems and not individual products. It is paramount fire protection systems are installed to uphold the prescribed fire performance of a structure, FSi offer this to the worldwide market.

All systems are manufactured to many global standards including CE, UL, FM, AS, ASTM and ISO. FSi manufacture fire protection, air permeability, movement, water permeability and acoustic isolation systems as well as general construction sealants, we offer support and training through our highly experienced technical team.

We pride ourselves on the high level of testing and technical expertise that has been built up through years of experience within the industry, from site installation to Multi-National distribution organisations. FSi ensure the correct solutions are specified and delivered to strict budgets and time scales ensuring technical specifications are met.

The FSi brand story is compelling, differentiated, and clearly expressed to internal and external audiences. We have included a company history on our website which has helped FSi stand out, emphasise benefits, humanise the brand, and enhance the technical capabilities. We continue our strategy that gives FSi the freedom and flexibility to explore and develop new product lines whilst keeping us aligned with our customers and future requirements. To grow in new markets, the brand needs to unite its international partners and through FSi this can be achieved.

FSi's brand has been embraced by employees, customers and suppliers. In-house training ensures that every FSi employee, from shop floor operative to management understand the important role they play in delivering intelligently every day.

FSi is a dynamic 16 year old brand that is ready for the next 16 years.

### Certification and Accreditation



### What is Compartmentation?

"Fire compartmentation is a vital part of any fire safety design. Compartmentation is a tool that is used in the vast majority of buildings, other than simple low rise developments. Compartmentation is referred to in many different ways: fire walls (and floors); fire separation; protected corridors / stairs etc. All these terms carry the same meaning.

Compartmentation is basically the division of a building into cells, using construction materials that will prevent the passage of fire from one cell to another for a given period of time. The most common feature of compartmentation that we all use and see on a day to day basis is a fire door. However, most building users forget that the surrounding construction will also be fire rated.

Compartmentation falls into the passive category as it doesn't typically react or change in a fire condition and this is one of its many advantages, as a feature, it is effectively a capital cost and can have little maintenance requirements, i.e. once a masonry wall is in place little will change throughout its 'life', it does not need a weekly test or a quarterly service, however, its integrity must be maintained. The most common problem with fire separation is that it frequently needs passing through, whether it is people (passing through fire doors) or building services, these create openings and therefore weaknesses within the separation. Specialist attention needs to be given to these breaches.

Fire Stopping is the generic term given to various components that are used to seal openings in fire compartmentation. The method adopted will differ greatly, depending on the type and size of the opening as well as the material that is passing through. Other systems, such as fire dampers are used where ductwork passes through fire walls. Technology and industry advances mean that fire separation (if installed properly) can have an enviable success rate, however, it is the weaknesses that must be continually considered, particularly with the constant changing environment in buildings requiring service alterations."



Lawrence Webster Forrest Fire Engineering and Fire Risk Management Consultants

As stated by the ASFP (Association for Specialist Fire Protection) "A building or part of a building, comprising one or more rooms, spaces or floors, constructed to prevent the spread of fire to or from another part of the same building, or an adjoining building. The basis of compartmentation is to subdivide buildings into areas of manageable risk, to provide adequate means of escape, and to provide fire separation for adjoining buildings."

Product Name	APPLICATION DESCRIPTION	APPROVALS					ADDITIONAL DATA		
		BS476	EN 1366	3rd PARTY ACCREDITED	CE Mark	UL US or EU	EN 10140	EN 1026	Movement
<b>Pyrocoustic® Sealant</b>	Pyrocoustic® Sealant has been tested for use in Block Wall, Concrete , Masonry and Plasterboard Partitions and Floors. Tested in Linear Joints up to 50mm wide, to be a used in conjunction with Stopseal® Fire Batts. Tested with Metallic Pipes, Cables, Cable Bunches, Cable Trays and Cable Ladders	✓	✓	✓	✓	✓	✓	✓	✓
<b>Pyrolastic® Fire Resistant Silicone</b>	Pyrolastic® Fire Resistant Silicone is tested for up to 4 hours in both horizontal and vertical joints. Joint movement capability of +/- 25%. Highly flexible and waterproof. Tested for internal and external use.	✓	✓	✓	✓	✓	✓	✓	✓
<b>PyroPro® LST Fire Resistant Sealant</b>	PyroPro® LST Fire Resistant Sealant is designed to resist the passage of fire, whilst maintaining smoke and toxicity levels. In normal use it will maintain the sound reduction index of a structure. Designed for use within concealed areas such as tunnels and the London Underground.	✓	✓	✓			✓	✓	
<b>Pyropro® HPE (High Pressure Exerting) Sealant</b>	Tested with Combustible Pipes up to 125mm dia – PVC, HDPE and ABS. Tested for use with sealing Armaflex and glass wool insulation. Suitable for use in irregular applications. Tested in linear joints up to 20mm wide. Tested in large service openings up to 300 x 100mm. Tested with Metallic Pipes, Cables, Cable Bunches (inc Telecommunication), Cable Trays and Cable Ladders. Tested in conjunction with the Stopseal® Fire Batt System.	✓	✓	✓	✓	✓	✓	✓	
<b>The Stopseal® 50/60mm Fire Batt</b>	The Stopseal® 50/60mm Fire Batt and Pyrocoustic® Sealant are designed to prevent the passage of fire and smoke between flexible walls, rigid walls and floors whilst still allowing the installation of services. Designed to seal cables, cable trays, cable ladders and metallic pipes. Suitable for large openings in walls and floors with additional supports.	✓	✓	✓	✓	✓	✓	✓	
<b>PipeBloc® PCP Pipe Collars</b>	The PipeBloc® PCP can be installed in flexible walls, rigid walls and floor constructions and is compatible with polypropylene (PP), polyethylene (PE) and PVC pipes. Pipe sizes from 32mm to 250mm.Can be used in conjunction with Stopseal® Fire Batt.	✓	✓	✓	✓	✓	✓	✓	
<b>PipeBloc® EL Pipe Wrap</b>	The PipeBloc® EL Pipe Wrap has been tested through flexible walls and rigid floors and walls. The pipes tested include PVC, PP, MDPE and PE up to a size of 200mm diameter. Can be used in conjunction with Stopseal® Fire Batt.	✓	✓	✓	✓	✓	✓	✓	
<b>PipeBloc® PWP Pipe Wrap</b>	The PipeBloc® PWP Pipe Wrap has been tested with pipes including PVC, PP, MDPE and PE up to a size of 200mm diameter, through flexible walls and rigid floors and walls.	✓	✓	✓	✓	✓	✓	✓	
<b>S-Line® Pillows</b>	S-Line® Pillows are Fire resistance tested in rigid walls & floors, with Metallic Pipes, Cables, Cable Bunches, Cable Trays and Cable Ladders. Suitable for indoor and outdoor locations up to 1m². Available in 3 sizes to ensure precise installation.	✓	✓	✓	✓	✓	✓	✓	
<b>Paraflam® C/UF/SE Cavity Barrier</b>	Paraflam® provides a seal between the ceiling and the underside of the floor. Paraflam® is used for the upgrade of wooden floors or heritage ceilings or between wooden joists forming the ceiling cavity. Pyrocoustic® Sealant can be applied around any services passing through. Paraflam® is also used under the removable access floor in a building where a partition wall is built above including voids between the slab edge and the outer skin of the building. Voids up to 590mm.	✓	✓	✓	✓	✓	✓	✓	
<b>Silverliner® Ventilated Rainscreen Cavity Barrier</b>	Silverliner® Rainscreen Cavity Barrier RCB is suitable to close up to 25mm ventilation gap (50mm gap is available). Voids up to 450mm wide. Superior level of sustainability. Available in Pre-Cut Sections for ease of application with minimum waste to suit void size. The aluminium foil facings provide class 'O' rating and excellent resistance to smoke.	✓		✓					
<b>Silverliner® Non-Ventilated Rainscreen Cavity Barrier</b>	Silverliner® Rainscreen Cavity Barrier RCB is suitable to close up to 25mm ventilation gap (50mm gap is available). Voids up to 500mm wide. Superior level of sustainability. Available in Pre-Cut Sections for ease of application with minimum waste to suit void size. The aluminium foil facings provide class 'O' rating and excellent resistance to smoke.	✓	✓	✓					
<b>Pass-It® Transit System</b>	Pass-It® Transit System designed to prevent the passage of fire between rigid floors, walls and flexible walls, offering smoke and acoustic isolation whilst still allowing for the easy installation/ removal of services. Instant entry/re-entry. Good acoustic isolation properties. 11 different size combinations.	✓	✓	✓			✓		
<b>LGS® Linear Gap Seal</b>	LGS® Linear Gap Seal has a joint movement capability of +/- 50% and is tested in Block Wall, Concrete and Masonry, Concrete Floors and Linear Joints up to 150mm wide. It can also be used as a fire barrier inside cable trunkings allowing for the installation of further cables. Highly flexible and water resistant.	✓	✓	✓			✓	✓	✓





Product Name	APPLICATION DESCRIPTION	APPROVALS					ADDITIONAL DATA			
		BS476	EN 1366	3rd PARTY ACCREDITED	CE Mark	UL US or EU	dB	EN 1026	LOAD-BEARING CAPACITY	MOVEMENT
<b>Silverseal® Compound (HS / STD)</b>	The intended use of Silverseal® Compound (HS / STD) is to reinstate the fire resistance performance of rigid wall and floor constructions where they are penetrated by various cables and metallic pipes. Load bearing compressive strength up to 20N/mm².	✓	✓	✓	✓	✓	✓	✓	✓	
<b>NS Putty®</b>	NS Putty® is tested on C1, C2 and D1 type cables, cable trays and metallic pipes. Tested in Block Wall, Concrete, Masonary and Plasterboard Partition. Tested in Concrete Floors and large service openings up to 250 x 150mm, Metallic Pipes, Cables, Cable Bunches, Cable Trays and Cable Ladders.	✓	✓	✓			✓	✓		
<b>NS Putty® Pads</b>	NS Putty® Pads are a range of intumescent putty pads developed to upgrade electrical socket boxes and light switches. Available in 2 sizes: 230 x 170 x 4mm or 170 x 170 x 4mm.	✓	✓	✓			✓	✓		
<b>Penopatch</b>	Penopatch is tested to EN 1366-3 around A1, A2, A3, B cables and H, I, E conduits. It is supplied at 60mm diameter and is suitable for apertures up to 25mm x 25mm maximum.		✓							
<b>Flexi-Coat®</b>	Flexi-Coat® is tested with Metallic Pipes, Cables, Cable Bunches, Cable Trays and Cable Ladders, Joint movement capability of +/- 50% -10 °C to +95 °C. Flexible linear joint sealing system. Suitable for voids up to 500mm wide, allows service movement in penetration seals.	✓	✓	✓	✓	✓	✓	✓		✓
<b>PS® Coating/ Ablative Coating</b>	PS® Coating is tested around metallic pipes, cables, cable trays and trunkings. Ideal for trowel, brush and pouring applications. At normal temperatures PS® Coating remains flexible to permit thermal and mechanical movement of services and the building structure.	✓	✓	✓	✓	✓	✓	✓		

Glossary of Terms	
CE Mark	CE Marking on a product is a manufacturer's declaration that the product complies with the essential requirements of the relevant European health, safety and environmental protection legislation. This is a declaration on performance by the manufacturer to meet product standards, Construction Products Regulation EU/305/2011.
UL Listing	UL certifies, validates, tests, inspects and audits. The UL Mark is the most common Certification Mark in the United States and Europe. If a product carries one of these marks, it means UL found that the representative product samples met UL's requirements.
Certifire	An independent third party certification scheme that assures performance, quality, reliability and traceability of fire protection products.
ETA	The European Technical Assessment is a document providing information about the performance of a construction product to be declared in relation to its essential characteristics. The ETA provides a way for the manufacturer to CE Mark a product.
Flexible Walls	A wall made from steel stud, gypsum board and mineral wool cavity with a thickness and make up appropriate to the required fire resistance classification.
Rigid Walls	A wall made of aerated concrete slabs, lightweight concrete or high density concrete and a thickness appropriate to the required fire resistance classification.
Rigid Floors	A floor made of aerated concrete slabs, lightweight concrete or high density concrete and a thickness appropriate to the required fire resistance classification.
EN 1366-3, EN 1366-4	Fire Resistance tests for service installations. Penetration seals. Fire Resistance tests for service installations. Linear joint seals.
EN 13501-1, EN 13501-2	Reaction to Fire Classification. Resistance to Fire Classification.
BS 476	Pt 20: Fire tests on building materials and structures. Method for determination of the fire resistance of elements of construction (general). Pt 22: Fire tests on building materials and structures. Methods for determination of the contribution of components to the fire resistance of a structure.

## Tested in Europe – Certified for the World UL – EN and BS Standards

These standards serve the same purpose in North America and Europe respectively, by providing a route for demonstrating the ability of fire stop products to maintain fire separation/ compartmentation and thus satisfy local building codes/regulations.

Although there are technical differences between the UL, EN and BS standards, certain codes and guidelines such as the 'UAE Fire and Life Safety Code of Practice - 2011 Edition' will accept tests conducted to either UL or EN standards and indeed other standards also, where the project specification allows it (see Chapter 1, Section 40).

European Standards	European Product Standards or EADs	North American Requirements	British Standards In accordance with BS 476: Part xx*
			
EN 1366-3	ETAG 026 Part 2	UL 1479, CAN/ULC-S115, ASTM E814	BS 476/20*
EN 1366-4	ETAG 026 Part 2	UL 2079, CAN/ULC-S115, ASTM E1966	BS 476/20*

When dividing a structure into compartments, fire is not the only thing to consider.

### Acoustic Isolation



Limiting or stopping the passage of sound is important, especially in residential buildings, schools and hospitals, where noise in one area could affect the occupants of another. Acoustic test results are expressed as decibels of sound reduction, i.e. by how much the tested product reduces the transmission of sound between compartments. This makes it easy for everyone from architect to end-user to satisfy regulations and specifications. Data from a laboratory test is expressed as  $R_w$  (weighted sound reduction). Field based test results are expressed in  $D_{ntw}$  (weighted, standardised level difference). For some tests, the result is given as  $D_{ntw} + C_{tr}$  (weighted, standardised level difference with low frequency correction applied).

### Air Tightness



FSi manufacture not only a range of fire resistance products but systems that offer complete compartmentation. A part of this is making sure a building is air tight. This is important to keep the costs of running a building down by ensuring cold air stays out and warm air stays within the building. This also has a positive impact on the environmental credentials of a building and with the Government wanting to achieve a 60% reduction in Carbon Emissions, using air tight products from the FSi range will help to achieve this. FSi tests to various air permeability standards such as EN 1026. Under the 2006 revision to Part L it is a regulatory requirement to conduct air permeability testing and Building Control will not be able to issue a completion certificate without it.

### Movement Testing



There can be a range of factors that can cause movement within a building which include, thermal, seismic and subsidence. This is most apparent in high rise buildings. Without taking the movement of the building into account it could lead to specific systems failing and compartmentation being breached. As part of our systems, FSi also offer products that can accommodate certain levels of movement within a building and in particular building elements. Movement is generally most apparent at the slab edge or curtain wall. FSi tests our Perimeter Seal Cavity Barriers to the EN 1366-4:2006+A1:2010 standard which tests the movement under fire conditions.

### Water Permeability



BS EN12208:2000. The Classification is based on a comparison of the water tightness of the test specimen related to test pressures and duration of the test. There nine classes; 1A/1B to 9A for test pressures from 0 Pa to 600 Pa. For specimens that remain watertight over 600 Pa for 5 minutes a class E<sub>xxx</sub> is used. The xxx is the maximum test pressure e.g. 750 Pa. To meet any class the specimen must remain watertight for 5 minutes up to and at the test pressure set for that class.

### VOC



Volatile Organic Compounds (VOCs) are present in all natural and synthetic materials, and can exist not only as structurally-diverse liquids and solids but also as vapours, and are thus a significant airborne consideration when biomonitoring human exposure levels, for analysing odour issues, and in the interest of food contact in particular regarding NIAS.

VOCs are measured by collecting samples and submitting for analysis in an independent laboratory, using techniques such as GC-MS to ensure that nothing harmful or toxic is present, by breaking down the airstream into constituent parts. FSi Systems have excellent data on systems with regards to VOC content.

### Substrate Compatibility

FSi ensure our systems are manufactured to the highest standards, before installation takes place, we would recommend a compatibility check is done. Constituents found in some coatings, such as intumescent paints, adhesives, sealants and residues of those materials may affect the product. Priming is not required with most construction materials but porous surfaces should be primed with a PVA Adhesive.



**FIRE STOPPING & COMPARTMENTATION SYSTEMS**

# Penetration Seals:

**Stopseal Batt<sup>®</sup>**

**Pyropro HPE<sup>®</sup>**

**PipeBloc PCP Collars<sup>®</sup>**

**PipeBloc EL<sup>®</sup>**

**PipeBloc PWP Wraps<sup>®</sup>**

**Silverseal HS Compound<sup>®</sup>**

**Silverseal STD Compound<sup>®</sup>**

**Stopseal Trowel Grade<sup>®</sup>**

**PS Coating<sup>®</sup>**

**Penopatch<sup>®</sup>**

**NS Putty Pads<sup>®</sup>**

**NS Putty<sup>®</sup>**

**S-Line Pillows<sup>®</sup>**

**Pass-it Transit System<sup>®</sup>**

Stopseal® Batt is a coated stone wool board used to reinstate the fire resistance performance of flexible & rigid wall and rigid floor constructions where apertures are penetrated by single or multiple services. The Stopseal® Batt is tested with a variety of services including multi composite pipes, metallic pipes, plastic pipes, all with or without insulation, cable trays and cables, as well as smoke extract and fire resistant ducts. The PipeBloc® and Pyropro HPE® range of reactive products has been tested for use with the Stopseal® Batt. Stopseal® Batts are supplied coated in both single and double side versions in 50mm and 60mm thickness.



## Key Product Points

- IET (IEE) 17th Edition Fire Stop Compliant to Regulation 527.1-3 - Electrical Installations.
- BS 7671-2008 Chapter 42 & 52 - Electrical Installations Fire Resistance.
- Fire resistance tested in flexible walls, rigid walls & floors, composite panel, CLT wall and Durasteel wall.
- Suitable for indoor use without additional environmental protection.
- Remains flexible.
- Life expectancy of over 25 years.
- Suitable for large openings in walls and floors with additional supports.

## KEY INSTALLATION POINTS

- For good adhesion the surfaces of the building elements shall be free of any dust or grease and may need to be primed. On good, clean virgin concrete & masonry, no priming required.
- Ensure that the aperture and services in question are tested with Stopseal® Batt and the site conditions are within the application specification.
- Measure the size of the opening, relevant position and size of the services. Mask all surfaces where necessary to ensure the aesthetics of Pyrocoustic® Sealant.
- Draw these details onto the Stopseal® Batt and cut out using a suitable saw.
- Using a trowel or pallet knife apply a thick layer of Pyrocoustic® Sealant to all areas of contact around the opening and services. Apply a similar thickness of Pyrocoustic® Sealant to the all edges of the cut Stopseal® Batt.
- Fit the cut Stopseal® Batt into the opening, ensuring a tight friction fit.
- Push the Stopseal® Batt firmly in to the opening using the flat of the hand. Continue the above procedure to fill the opening ensuring that a layer of Pyrocoustic® Sealant is applied to all areas of contact between the boards. The seal should be made up from as few pieces of Stopseal® Batt as practicable.
- Any small gaps in the seal left when all cut pieces have been installed should be tightly packed with off -cuts and coated with Pyrocoustic® Sealant. A layer of Pyrocoustic® Sealant should be applied to all joint lines formed.
- To complete the installation a small bead of Pyrocoustic® Sealant should be applied around the extremities of the opening and services. Whatever the edges of the seal line with the wall / floor surface, the bead of Pyrocoustic® Sealant should be smoothed to overlap the wall / floor surface by approximately 5mm.
- A Stopseal® double Batt system may have a requirement for structural supports, they should be steel back to back angles circa 40mm x 40mm x 1.2mm thickness. All joints to be off-set or staggered.

*When cable trunking pass through the seal ensure that the inside is filled with S-Line® sausage pillows.*

## Certifications and Approvals

- EN 1366-3, EN 1366-1, EN 1366-8, BS476 20&22 and 1121-CPR-JA5021, ETA 14/0005
- EN 13501-1, EN 13501-2 and EN 13501-3
- EN 10140, EN1026 and EN 717-1
- UL-EU-00771, Certifire CF513, ASTM D2369-10 and UAE Certificate of Compliance
- LEED 2009-EQ041 SCAQMD, ISO 51:2008
- BREEAM International Approved

### Tool Used For Installation

	Cartridge Gun
	Dust pan and Brush
	Float
	Masking Tape
	Spatula
	Pencil and Ruler
	Plastic Sheet
	Tape Measure
	Bread Knife
	Paint Brush
	Green Wipe





**Typical Layout Fsi Stopseal® Batt System Rigid Walls, Floors and 100mm Flexible Wall Systems**

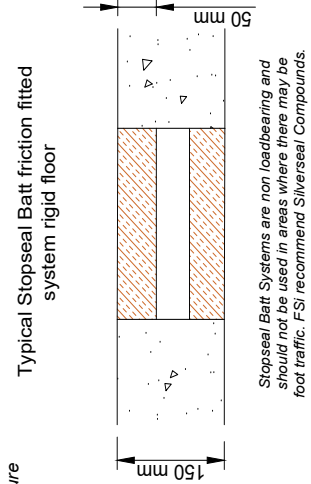
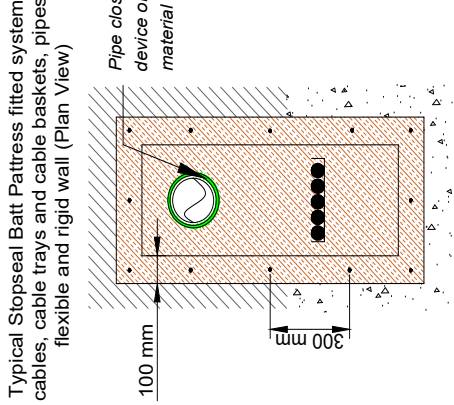
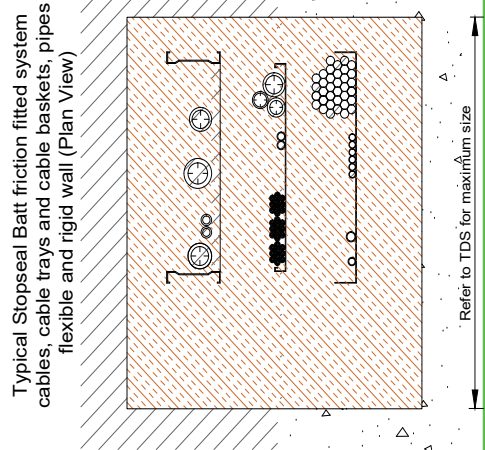
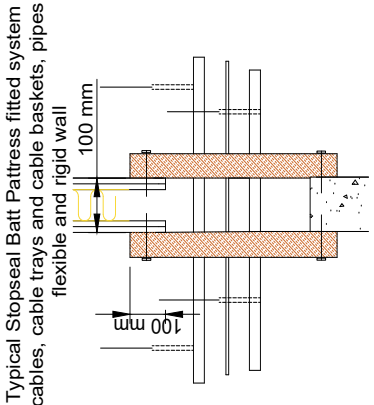
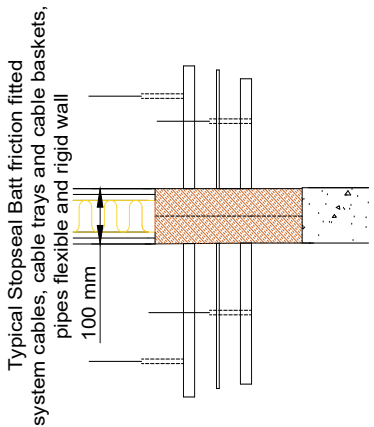
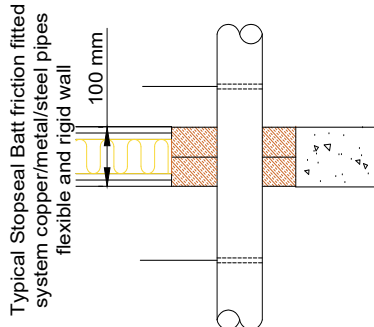
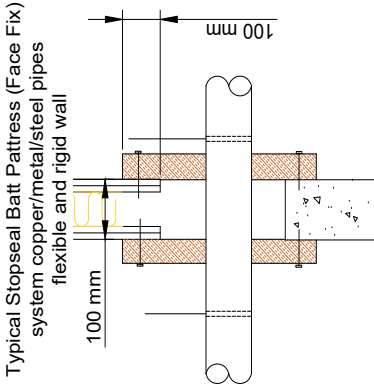
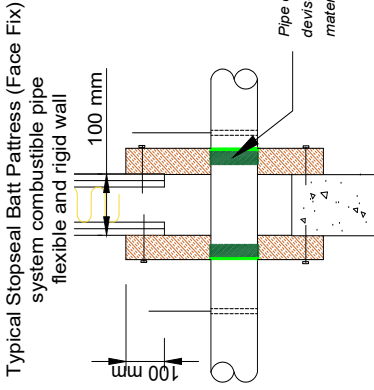
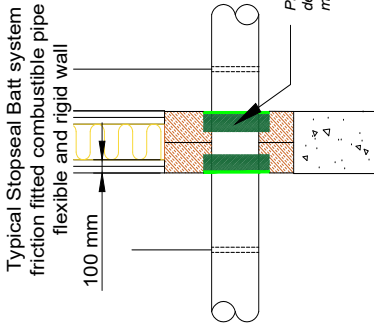

**Key Installation Guidance**

FSI Stopseal Batt system must be installed under friction fitting using Pyrocoustic to all edges ("buttered up") and joints, junctions and around all services including between cables and cable trays.

For Pattress fitting the Stopseal Batt System, mechanical fixings must be used. The Stopseal Batt must be overlapped onto the substrate by a **minimum 100mm**. Mechanical fixings are minimum 80mm Steel Wood Screws and Penny washers at maximum 300mm centres or at least at every corner or cut corner.

Penny washers do not need over coating **ALL exposed edges of the Stopseal Batt System MUST BE coated to minimum 1mm DFT (Dry Film Thickness) using Pyrocoustic Sealant or Stopseal Coating.**

Refer to the Stopseal Technical Data Sheet for size and service limitations and parameters for floors and walls including treating combustible pipes and insulated copper/metal and steel pipes.

Closure device or material:  
For PipeBloc PCP Pipe Collar, PyroPro HPE, PipeBloc EL/PWP Intumescent Wrap Systems and Stopseal Wrap Systems refer to each products Technical Data Sheet and typical details.

Drawing Number / Name :	Typical Stopseal® Batt Handbook
Date :	April 2018
Scale :	N/A

© Copyright FSI Ltd 2018

The information and recommendations given herein are believed to be correct at the time of writing. Any data referred to has been obtained from tests done under laboratory, or other controlled, conditions and it is the users' responsibility to use the data given in the light of conditions on site and taking account of the intended use of the products concerned. Whilst FSI Limited can give general guidance and advice, the nature of FSI products means that the ultimate responsibility for selecting the correct product for a particular application must lie with the customer. All descriptions and illustrations in this proposal/solution are intended for guidance only and shall not constitute a 'Sale by description' picture'. All dimensions given are nominal and FSI Limited may change the information, products and specifications from time to time for a variety of reasons, without prior notice. The information in this proposal/solution is provided 'as is' at the date specified.

Pyropro HPE® Sealant is a water based, acrylic sealant utilising a reactive formula that has intumescent properties to reinstate the fire resistance performance of wall and floor constructions where the penetrations of single or multiple services are present.

Pyropro HPE® Sealant expands upon contact with heat, the high pressure reactive process ensures that the material will expand up to 20 times under an expansion pressure of 7 bar. Pyropro HPE® Sealant is supplied in liquid form in 310ml cartridges, 600ml foils and 5kg, 10kg and 20kg pails. The sealant is gunned or trowelled into the annular space in or between the separating elements to a specific depth in order to maintain the fire resistance of the construction in the event of a fire.



## Key Product Points

- Rigid wall and floors, flexible wall and batts in wall and floor.
- Linear Joints up to 20mm wide.
- Large service openings up to 300mm x 100mm.
- Batt aperture up to 1100mm x 750mm.
- Metallic Pipes, Cables, Cable Bunches (inc Telecommunication), Cable Trays and Cable Ladders.
- Combustible Pipes up to 125mm dia - PVC, PE, PP, ABS and PEX / MLC .
- Sealing elastomeric foam and glass wool insulation in irregular applications.
- Causes no known affects to plastic pipes, plastic cables, sheathing or metallic components.











## KEY INSTALLATION POINTS

- For good adhesion the surfaces of the building elements shall be free of any dust or grease and may need to be primed. On good, clean virgin concrete & masonry, no priming required, though refer to substrate compatibility requirements.
- Ensure that the aperture and services in question are tested with Pyropro HPE® and the site conditions are within the application specification. An annular space needs to be present around the service to apply sufficient installation depth.
- Consider the characteristics of all available sealants for performance capabilities, hardness after weathering, movement capabilities in both extension and compression, adhesion properties and chemical resistance.
- Combustible service penetrations must be independently supported each side of the seal.
- Mineral wool (min. 80kg/m³) or PE backing rod where required can be used as backing material for Pyropro HPE® Sealant. Backing material is not needed within all installations, though the Pyropro HPE® Sealant should be installed correctly to achieve the performance needed. Leave a minimum depth of 25mm to install HPE.
- Apply Pyropro HPE® to the remaining space around the penetrations. The sealant should be installed to the minimum 25mm depth within a minimum 20mm annulus around the service.
- Once the Pyropro HPE® has been installed to the specified depth on both faces of the penetration seal, smooth over the seal. This can be done with a spatula and water.

## Certifications and Approvals

- EN 1366-3, EN 1366-4 and EN 13501-2
- EN 10140, EN 1026 and EN 717-1
- ASTM D2369-10 and UAE Certificate of Compliance
- LEED 2009-EQ041 SCAQMD
- 1121-CPR-JA5023, ETA 14/0044
- UL-EU-00770 and Certifire CF 5127
- Lubrizol Approved and BREEAM International Approved

### Tool Used For Installation

	Cartridge Gun
	Dust pan and Brush
	Float
	Masking Tape
	Spatula
	Pencil and Ruler
	Plastic Sheet
	Tape Measure
	Knife
	Green Wipe



**Typical Layout FSi PyroPro® HPE High Pressure Expanding Sealant in Floors, Rigid and 100mm Flexible Wall Systems**

Typical PyroPro HPE Elastomeric and Glasswool insulated copper/metal/steel pipe flexible and rigid wall

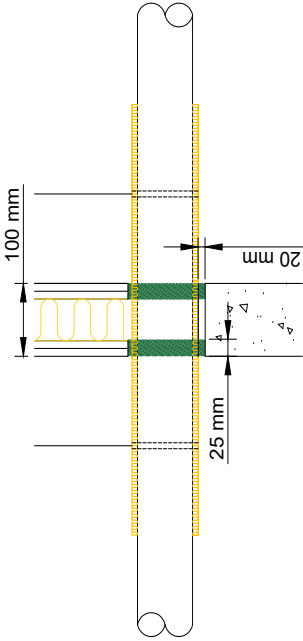

Typical PyroPro HPE combustible pipe flexible and rigid wall with Stonewool 45kg/m³ density backing

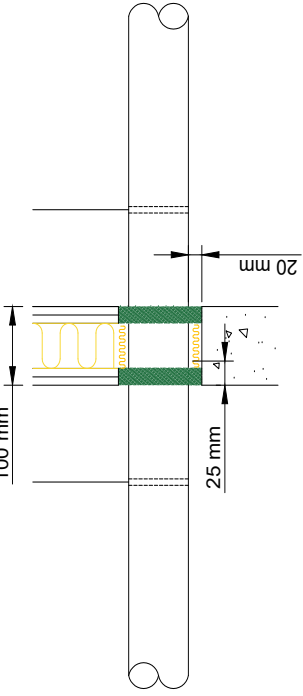

Typical Stopseal Batt PyroPro HPE system combustible pipe in flexible and rigid walls

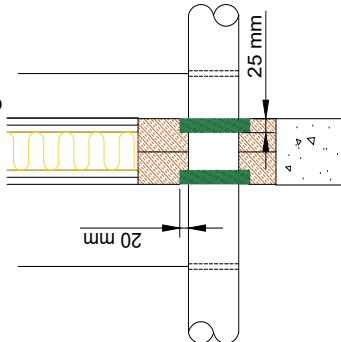

Insulated copper/metal/steel pipe rigid floor with Stonewool 45kg/m³ density backing

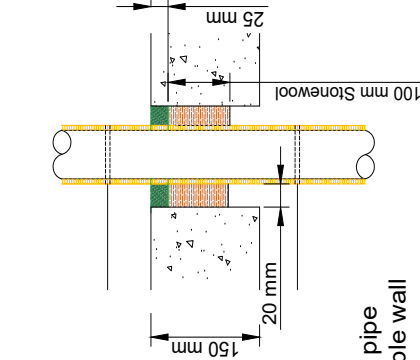

Combustible pipe rigid floor with Stonewool 45kg/m³ density backing

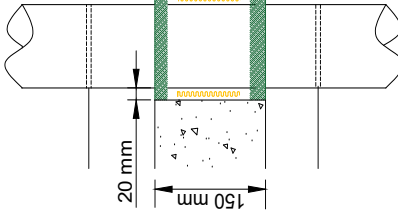

Cables rigid floor with Stonewool 45kg/m³ density backing

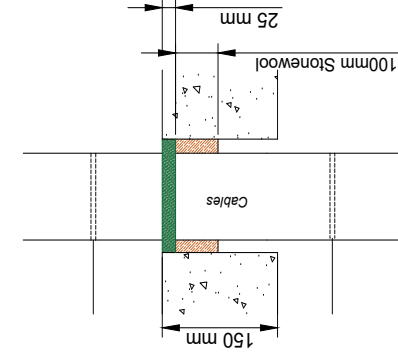

Typical plan view combustible pipe Stopseal Batt with rigid and flexible wall

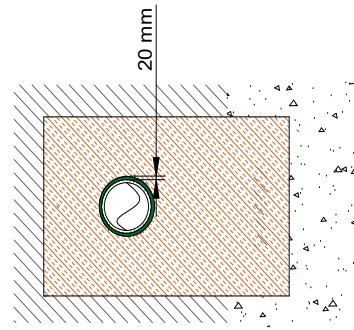

Typical plan view insulated copper/metal/steel pipe rigid floor

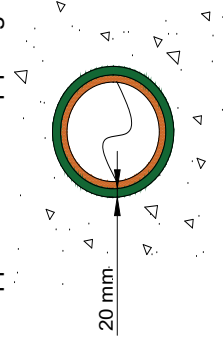

Typical plan view blank seal rigid floor with 45kg/m³ density Stonewool

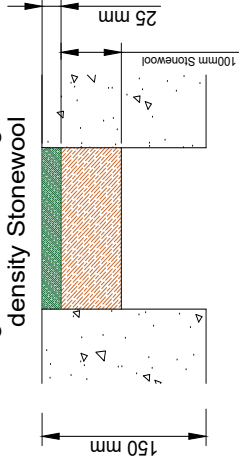

**Key Installation Guidance**

FSi PyroPro HPE Sealant must be installed to a minimum depth of 25mm and have a minimum annulus of 20mm.

PyroPro HPE Sealant must be installed at minimum 25mm depth and 20mm annulus around Elastomeric and Glasswool insulation. **For Phenolic Insulation refer to PipeBloc EL Intumescent Pipe Wrap.**

Stonewool backing must be 100mm depth and minimum required 45kg/m³ density.

For single side PyroPro HPE Sealant seals in floors please refer to Technical Data sheet for limitations and parameters.

For Stopseal Batt Systems refer to Stopseal Batt Systems guidance for fixing methods.

Refer to Technical Data Sheet for service size limitations and parameters. For requirements beyond the Technical data Sheets consult FSi Technical Team.

Drawing Number / Name: **Typical PyroPro® HPE Handbook**

Date: **April 2018**

Scale: **N/A**

© FSI (Member of the FSI Group of Companies)

PipeBloc® PCP Collars are designed and tested to seal service penetration apertures containing plastic and metallic pipes both with and without insulation. PipeBloc® PCP has been developed to provide a high volume expansion and pressure seal in the event of a fire. The PipeBloc® PCP Collars can be used on pipes to a maximum diameter of 250mm for internal and external applications. The ultra-thin profile of PipeBloc® PCP Collars shells, a depth of 30mm or 40mm allows for the installation into the tightest of locations.



## Key Product Points

- Can be used in flexible walls, rigid floors and with Stopseal® Batt.
- PipeBloc® PCP is supplied up to 250mm diameter.
- Can be use with Plastic Pipes - PVC, HDPE, PP, PE, ABS, PVC-C and SAN + PVC.
- Can be used to close off various types of insulation around metallic pipes.
- Causes no known effects to plastic pipes.
- Ease of fixing to suit location 40mm maximum collar depth
- Ease of fixing only 3 fixing points required.

## Certification and Approvals

- EN 1366-3
- EN 13501-1 and EN 13501-2
- Etag 026 Type X
- 1121-CPR-JA5080, ETA 15/0489 and UAE Certificate of Compliance
- UL-EU-00942 and Certifire CF5367









## KEY INSTALLATION POINTS

- For good adhesion the surfaces of the building elements shall be free of any dust or grease and may need to be primed. On good, clean virgin concrete & masonry, no priming required.
- Ensure that the aperture and services in question are tested with PipeBloc® PCP and the site conditions are within the application specification. A maximum 10mm annular space needs to be present around the services. Which is filled to a minimum 5mm depth of Pyrocoustic® Sealant prior to the installation of the PipeBloc® PCP Collar.
- Ensure you are using the correct collar size for the pipe penetration.
- Place the PipeBloc® PCP collar around pipe and hold in place using the slide clip to slip through the loop and fix the PipeBloc® PCP collar tightly by bending the slide fully back.
- Slide Pipebloc® PCP Collar into place to ensure a snug fit to the surrounding building element.
- Ensure fixings are as per:

- 3 No. 60mm x 6mm Expanding Anchors for **Rigid Floors**
- 3 No. Size 70 Wood Screws for **Rigid Walls**
- 3 No. 65 mm Spider Fixings for **Flexible Walls**
- 3 No. 35mm Tap in Fixings for **Rigid Wall and Floors**
- 3 No. 80mm Pig tails for **Stopseal® Batt** installation

**NO PLASTIC OR COMBUSTIBLE FIXINGS MAY BE USED TO SECURE THE PIPEBLOC® PCP COLLAR TO SERVICES OR SUBSTRATES**

### Tool Used For Installation

	Cartridge Gun
	Dust pan and Brush
	Spatula
	Pencil and Ruler
	Tape Measure
	Fixings
	Screwdriver
	Green Wipe

**Typical Layout Fsi PipeBloc® PCP Intumescent Pipe Collar in Rigid Floors, 100mm Flexible Wall Systems and Stopseal® Batt Systems**



PipeBloc PCP in rigid and flexible walls with combustible pipes

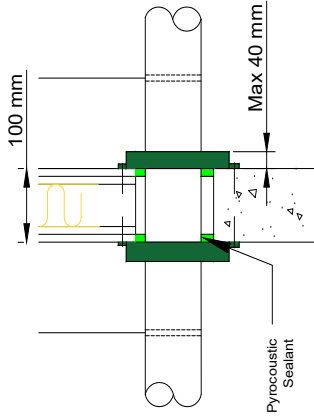

PipeBloc PCP in Stopseal Batt System with combustible pipes

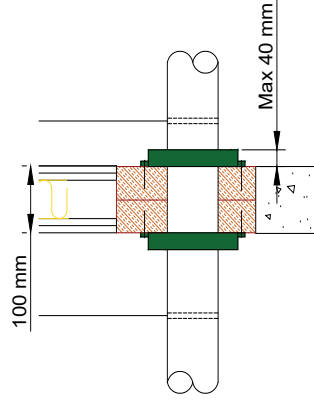

PipeBloc PCP Pattress (face fix) Stopseal Batt System with combustible pipes

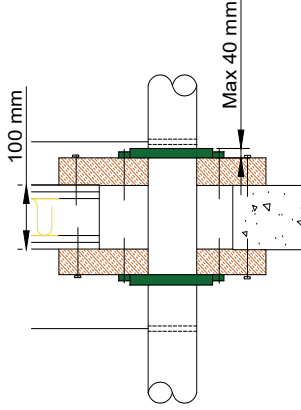

PipeBloc PCP in rigid floors with combustible pipes section view

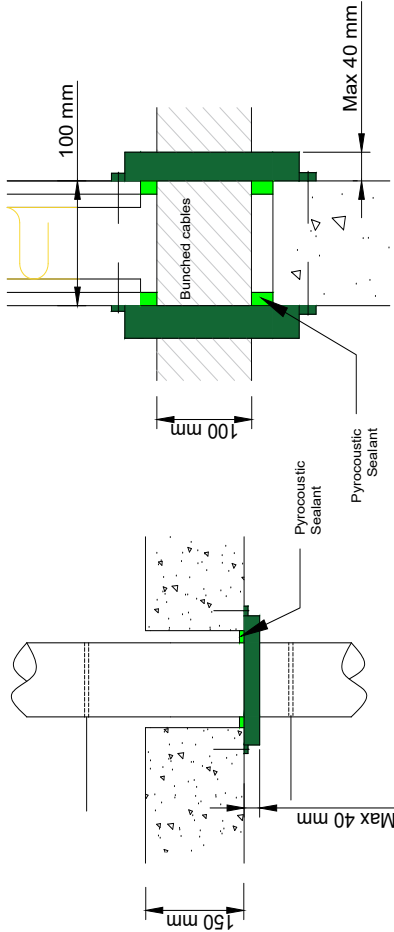

PipeBloc PCP in rigid and flexible walls with 100 mm Ø bunched telecom cables

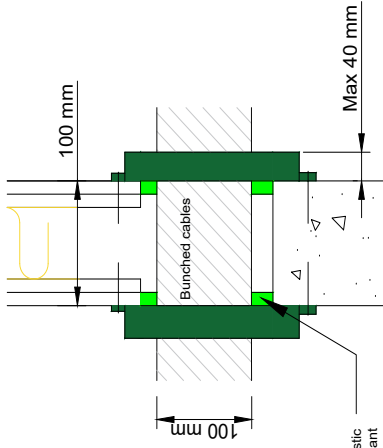

PipeBloc PCP in rigid and flexible walls up against soffit (Open State Plan view)

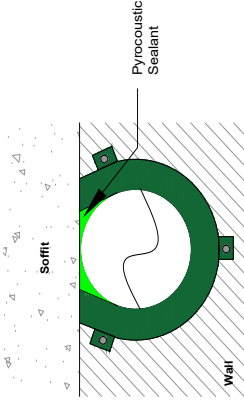

Typical PipeBloc PCP in rigid floors, rigid and flexible walls plan view

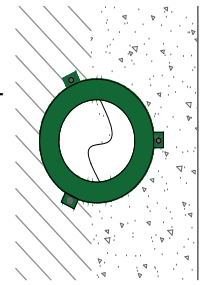

**Key Installation Guidance**

FSI PipeBloc PCP Collars are supplied in 30mm and 40mm deep.

Use FSI Pyrocoustic Sealant around the service to seal any gap between the service and the substrate (5mm depth) prior to fitting the PipeBloc PCP Intumescent Pipe Collar.

FSI PipeBloc PCP Intumescent Pipe Collar must be installed by using the correct anchor fixings for the substrate. PipeBloc PCP Intumescent Pipe Collars must be fixed to **both sides of the wall** and the underside of a rigid floor.

**Flexible Wall Systems:**

Use 80mm Steel Wood Screws and Penny washers or 65 mm Spider fixings for flexible walls.

**Stopseal Batt System:**

Use 80mm "Pig Tail" Fixings.

**Rigid Walls and Floors:**

60mm x 6mm Expanding Anchors Rigid Floors or 35mm Tap-in Fixings Rigid Wall and Floors

Ensure all minimum fixing points are used (3) to fix the PipeBloc PCP Intumescent Pipe Collar

Consult FSI Technical Data Sheets for service size limitations and parameters.

Drawing Number / Name

Typical PipeBloc® PCP Pipe Collars Handbook

Date: April 2018

Scale: N/A

PipeBloc® EL is designed and tested to seal service penetration apertures containing plastic and metallic pipes both with and without insulation. PipeBloc® EL is formulated with thermoplastic composites based on reactive intumescent technology, it has been developed to provide a high volume expansion and high pressure seal in the event of a fire. PipeBloc® EL offers a solution on pipes with a maximum diameter of 200mm.

PipeBloc® EL allows for a variety of wall thickness's for internal and external applications. The ultra-thin design ensures that the EL wrap can be installed into the tightest of locations. PipeBloc® EL can be installed in flexible wall, rigid wall, and rigid floor. PipeBloc® EL can also be installed directly in to the Stopseal® Batt System seal. PipeBloc® EL comes as a 25 metre roll.



### Key Product Points







- Can be used in flexible walls, rigid floors and Stopseal® Batt.
- PipeBloc® EL is supplied in a convenient 25m long, 40mm wide roll.
- Can be use with Plastic Pipes - PVC, HDPE, PP, PE, ABS, PVC-C and SAN + PVC.
- Can be used to close off various types of insulation around metallic pipes.
- Causes no known effects to plastic pipes.
- Halogen free, contains no asbestos, ceramic or mineral fibres.

### KEY INSTALLATION POINTS

- For good adhesion the surfaces of the building elements shall be free of any dust or grease and may need to be primed. On good, clean virgin concrete & masonry, no priming required.
- Ensure that the aperture and services in question are tested with PipeBloc® EL and the site conditions are within the application specification. An annular space needs to be present around the service to apply sufficient installation depth.
- Make sure that you have the correct wrap size for the type and size of pipe.
- Ensure where required or centrally within the wall that two wraps are used in the installation sealing of both sides.
- Ensure the mesh is facing away from the penetrating service and is help in place using any tape once the correct number of wraps as required for the pipe size.
- Ensure when used in rigid floors that the wrap is installed as required in rigid floors, with regards to location of wrap. Within the Silverseal® Compounds the wrap is installed centrally within the Silverseal Compounds taking in to account the correct wrap size for the type and size of the pipe.
- Install the wrap into the wall around the service using the self adhesive strip. leaving 5mm from the front face of the penetration seal, thus allowing the gap to be filled with Pyrocoustic® Sealant to fill the 5mm gap. Ensure that this is done on both sides of the penetration seal. See typical detail for guidance.

### Certification and Approvals

- EN 1366-3
- EN 13501-1, EN 13501-2
- 1121-CPR-JA5082, ETA 15/0491
- UL-EU-01023-CPR, Certifire CF5368
- UAE Certificate of Compliance

Tool Used For Installation	
	Cartridge Gun
	Dust pan and Brush
	Spatula
	Pencil and Ruler
	Tape Measure
	Knife
	Green Wipe

**Typical Layout FSI PipeBloc® EL Intumescent Pipe Wrap in Floors, Rigid and 100mm Flexible Wall Systems**

Phenolic, Elastomeric and Glass-wool insulated copper/metal/steel pipe flexible and rigid wall

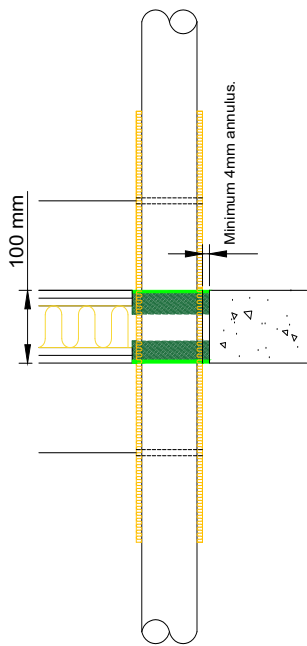

Combustible pipe flexible and rigid wall

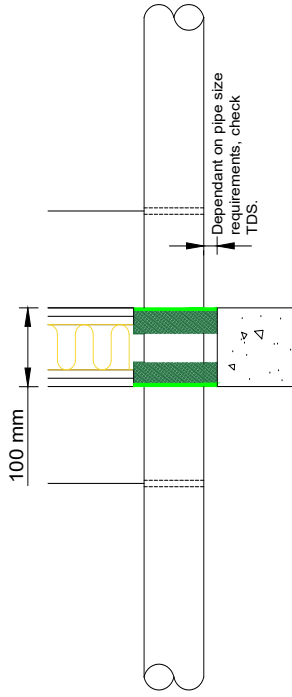

Combustible pipe rigid floor

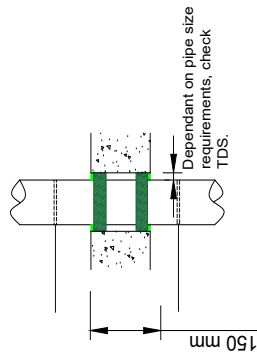

Typical 204 x 60 Flat PVC duct in flexible and rigid wall system

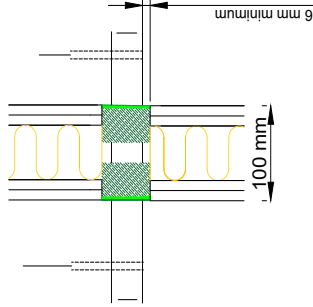

Expanded detail showing Pyrocoustic Sealant over face

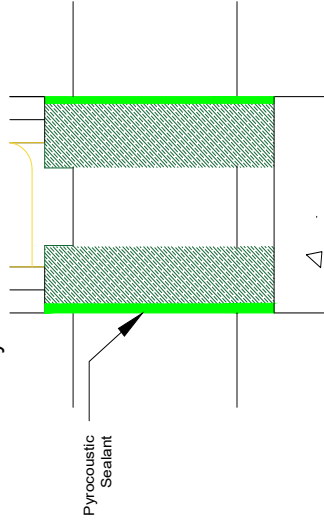

Combustible pipe rigid floor single wrap  
(Wrap thickness increased with single wrap)

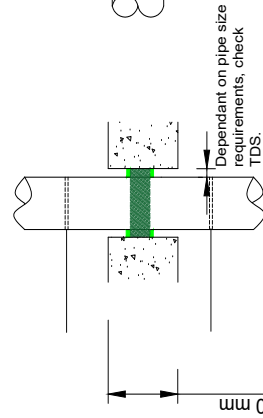

Typical Stopseal Batt System combustible Pipe in flexible and rigid walls

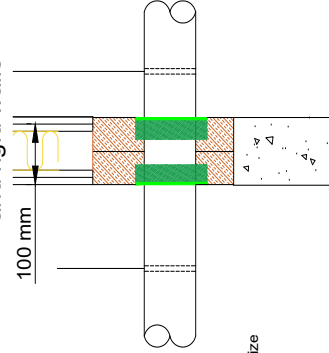

Typical Pattress (Face Fix) Stopseal Batt System combustible pipe and non combustible pipe with Elastomeric, Phenolic and Glass-wool insulation in flexible and rigid walls

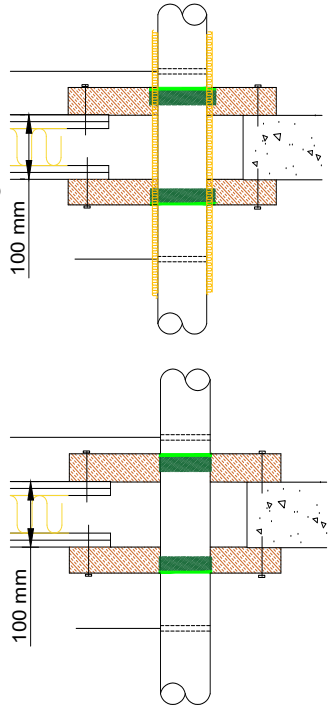

Westminster Insulation Estimate, Ltd. UK  
Tannwood Way, Tamworth, B77 2JG  
TEL: +44 (0)1827 515150  
www.fsiid.com

**Key Installation Guidance**

FSI PipeBloc EL Intumescent Wrap roll must be installed with the number of wraps required depending on the Ø of the combustible service. The "mesh" on the PipeBloc EL must face away from service during installation. Refer to Technical Data Sheet for service size limitations.

PipeBloc EL Intumescent Pipe Wrap installed around Phenolic, Elastomeric and Glasswool insulation with 2 layers, total thickness minimum 4mm thick.

For single PipeBloc EL Intumescent Pipe Wrap in rigid floor consult FSI Technical Data Sheets for annulus minimums and increase in wrap thickness parameters.

PipeBloc EL Intumescent Pipe Wrap must be installed from both sides of the aperture in flexible and rigid walls.

Ensure the PipeBloc EL Intumescent Wrap is pushed back inside the void a minimum 5mm depth and seal face using Pyrocoustic Sealant.

For Stopseal Batt Systems refer to the Stopseal Batt Systems guidance for fixing methods.

Drawing Number / Name :  
**Typical PipeBloc® EL Handbook**  
Date :  
**April 2018**  
Scale :  
**N/A**

PipeBloc® PWP Wraps are designed and tested to seal service penetration apertures containing plastic pipes formulated with thermoplastic composites based on reactive intumescent technology. The individual PWP Wraps have been developed to provide a high volume expansion and pressure seal during a fire. The PipeBloc® PWP wraps can be used to a maximum diameter of 200mm. The ultra-thin design of PipeBloc® PWP wraps ensures that they can be installed into the tightest of locations.



## Key Product Points







- Fire resistance tested in flexible walls and rigid floors.
- Tested with Plastic Pipes - PVC, HDPE, PP and PE.
- Causes no known effects to plastic pipes.
- Suitable for wall and floor installation and in Stopseal® Batt system.
- The product is based on an thermoplastic composite and is therefore non-toxic.
- Halogen free, contains no asbestos, ceramic or mineral fibres
- Not affected by fungus, vermin or rodents.
- Can be used in areas of high humidity.

## Certification and Approvals

- EN 1366-3
- EN 13501-1
- EN 13501-2
- Etag 026 Type X
- 1121-CPR-JA5081, ETA 15/0490
- UL-EU-01022-CPR
- Certifire CF5369
- UAE Certificate of Compliance

## KEY INSTALLATION POINTS

- For good adhesion the surfaces of the building elements shall be free of any dust or grease and may need to be primed. On good, clean virgin concrete & masonry, no priming required.
- Ensure that the aperture and services in question are tested with PipeBloc® PWP and the site conditions are within the application specification. An annular space needs to be present around the service to apply sufficient installation depth.
- Make sure that you have the correct wrap size for the type and size of pipe.
- Ensure where required or centrally within the wall that two wrap are used in the installation sealing of both sides.
- Ensure when used in rigid floors that the wrap is installed as required in rigid floors, with regards to location of the wrap. Within the Silverseal® Compounds the wrap is installed centrally taking into account the correct wrap size for the type and size of the pipe.
- Install the wrap into the wall around the service using the self adhesive strip. leaving 5mm from the front face of the penetration seal, thus allowing the gap to be filled with Pyrocoustic® Sealant to fill the 5mm gap. Ensure that this is done on both sides of the penetration seal.

Tool Used For Installation	
	Dust pan and Brush
	Masking Tape
	Spatula
	Pencil and Ruler
	Plastic Sheet
	Tape Measure
	Green Wipe



**Typical Layout FSI PipeBloc® PWP Intumescent Pipe Wrap in Floors, Rigid and 100mm Flexible Wall Systems**



Combustible Pipe Flexible and Rigid Wall

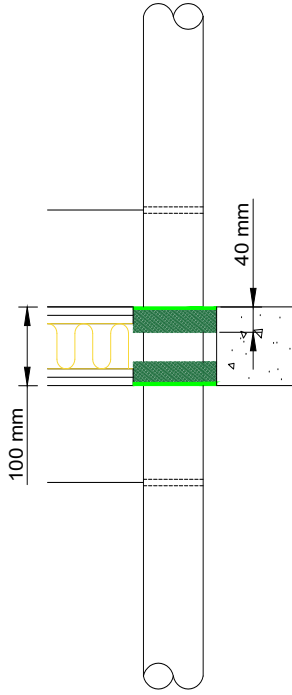

Typical Close up detail showing Pyroacoustic Sealant over face

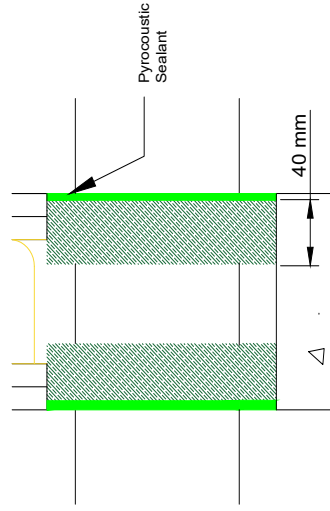

Typical Stopseal Batt System friction fitted combustible pipe and pipe wrap

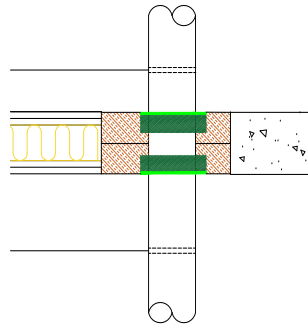

Combustible pipe rigid floor

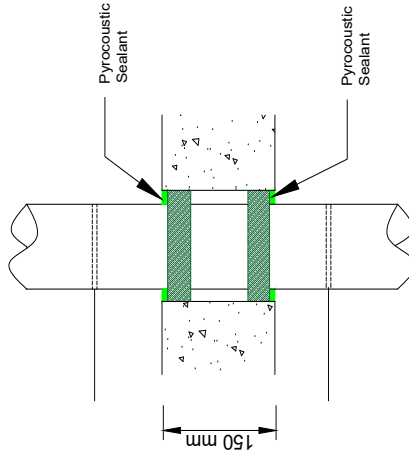

Typical Stopseal Batt Pattress (face fix) Batt System combustible pipe

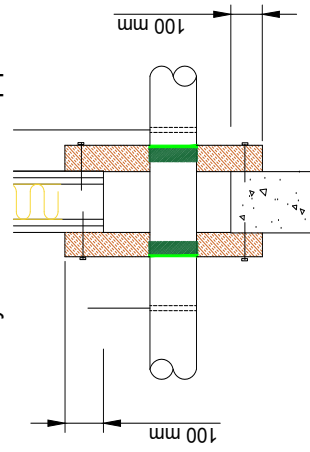

Typical plan view combustible pipe rigid floor

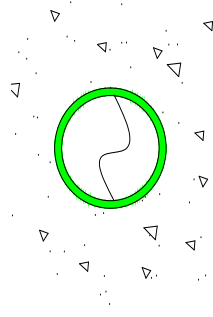

**Key Installation Guidance**

FSI PipeBloc PWP Intumescent Wrap must be installed with the correct wrap size for the Ø of the combustible pipe.

PipeBloc PWP Intumescent Pipe Wrap must be installed **from both sides** of the aperture.

Ensure the PipeBloc PWP Intumescent Pipe Wrap is pushed back inside the aperture to a minimum 5mm depth and **seal face using Pyroacoustic Sealant.**

For Stopseal Batt Systems refer to Stopseal Batt Systems guidance for installation requirements.

Refer to Technical Data Sheet for service size limitations or contact FSI Technical Department.

Drawing Number / Name :	Typical PipeBloc® PWP Handbook
Date :	April 2018
Scale :	N/A

The information and recommendations given herein are believed to be correct at the time of writing. Any data referred to has been obtained from tests done under laboratory, or other controlled, conditions and it is the users' responsibility to use the data given in the light of conditions on site and taking account of the intended use of the products concerned. Whilst FSI Limited can give general guidance and advice, the nature of FSI products means that the ultimate responsibility for selecting the correct product for a particular application must lie with the customer. All descriptions and illustrations in this proposal/solution are intended for guidance only and shall not constitute a 'Sale by description' picture'. All dimensions given are nominal and FSI Limited may change the information, products and specifications from time to time for a variety of reasons, without prior notice. The information in this proposal/solution is provided 'as is' at the date specified.

Silverseal® HS Compound is a high strength gypsum based compound, used to reinstate the fire resistance performance of floor and wall constructions where they have been provided with apertures for the penetrations of multiple services. Silverseal® HS Compound is supplied as a dry material, and is mixed with water to the required ratio prior to installation. Silverseal® HS Compound is self supporting in floor spans up to **1800mm**.



## Key Product Points

- Can be used in rigid floors and walls with fire rated dampers.
- Rapid setting, zero shrinkage formulation - can be used as pourable or trowel grade, gas tight seals.
- Excellent workability ranging from stiff to pourable mix.
- Good load bearing performance in floor seals, \*No structural support required for seals up to 1800mm spans. \*Silverseal® Compounds can be waterproofed. \*(Consult FSi for details)

## Certification and Approvals

- EN 1366-3, BS 476
- EN 13501-2
- EN 717-1
- BS 6399
- BS 476 20 & 22
- 1121-CPR-JA5039, ETA 14/0280
- UL-EU-00924-CPR
- BREEAM International Approved
- BS6399-1 Loading for Buildings “Code of Practice for dead and applied loads”.

## KEY INSTALLATION POINTS

- For good adhesion the surfaces of the building elements shall be free of any dust or grease and may need to be primed. On good, clean virgin concrete & masonry, no priming required.
- Ensure that the aperture and services in question are tested with Silverseal® Compounds and the site conditions are within the application specification.

Silverseal® HS Compound can be mixed preferably by mechanical paddle or manually if required. Measure out the correct amount of clean water into a clean container to achieve the desired consistency.

**(Silverseal® HS Compound: water ratio):**

**Pourable Mix ratio of 3 - 3½: 1    Trowelable Mix ratio of 4: 1**









Gradually add the Silverseal® HS Compound stirring continually. Continue mixing until the Silverseal® HS Compound is mixed to a smooth even consistency. Any spillage should be wiped up with a damp cloth before setting occurs as it may stain pipes and services. Mix only enough material sufficient for use within the recommended pot life (20-30 minutes). Pot life and set times will be reduced for lower water content and higher temperatures.

Installation should not be carried out when temperatures are above 35°C. Setting times are normally between 30 and 90 minutes. **Warning:** Do not attempt to extend working time by remixing with additional water once the compound has started to set, as this will interfere with the setting process. Always mix in clean buckets. Using dirty buckets containing remains of compound from earlier mixes may reduce working time.

Fit damming board/shuttering to bottom of opening. Damming materials must be able to support the wet weight of the compound under pouring conditions.

**Silverseal® HS Compound must be installed to the required minimum 100mm thickness.**

### Tool Used For Installation

	Dust pan and Brush
	Float
	Masking Tape
	Spatula
	Pencil and Ruler
	Plastic Sheet
	Tape Measure
	Mixing Tool
	Green Wipe



**Key Installation Guidance**

Formwork or shuttering is typically FSI Stopseal Batt or non combustible materials capable of supporting the wet weight of the compound which is approximately 130 kg/m<sup>2</sup> at 100mm thickness.

Formwork/Shuttering may involve creating a framing system. ALL Non combustible shuttering does not need to be removed.

For rigid floors the Silverseal must be poured at **100 mm depth** as a single pour. Loadbearing based on the flexural strength of the Silverseal Compounds 2.5k N/m<sup>2</sup> UDL

BS6399-1:  
Silverseal HS 2.0 N/mm<sup>2</sup>  
Silverseal STD 1.3 N/mm<sup>2</sup>  
For loadbearing calculations please contact FSI Technical Department.

FSI PipeBloc EL/PWP Pipe Wrap must be installed centrally within the Silverseal Compound where there are combustible pipes.

Insulation should be removed where it passes through the Silverseal Compounds. Contact FSI Technical team for guidance.

Consult FSI Technical Data Sheets for service size limitations and parameters.

Drawing Number / Name :  
**Typical Silverseal® Compounds Handbook**

Date : **April 2018**  
Scale : **N/A**

© 2018 FSI Ltd. All rights reserved.

**Typical Layout FSi Silverseal® Fire Resistant Loadbearing Compounds in Rigid Floors and Walls.**

Silverseal STD Compound in rigid floors with copper/steel/metal. Combustible pipes with PipeBloc EL/PWP pipe wraps

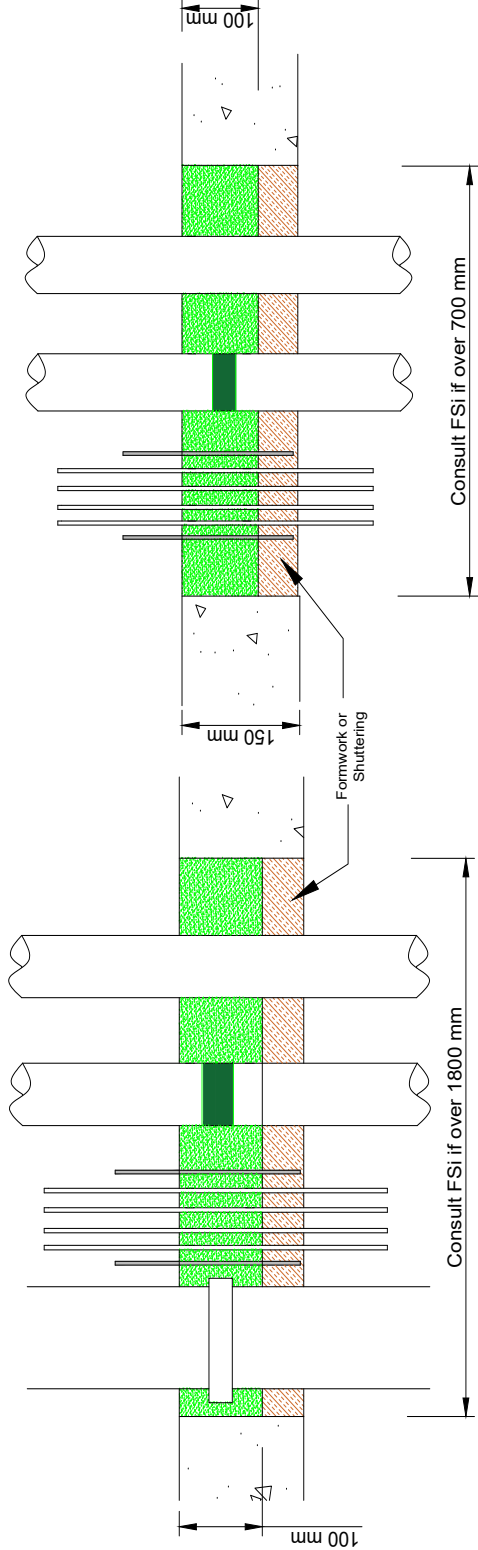

Silverseal HS Compound in rigid floors with copper/steel/metal pipes and cables. Combustible pipes (Pattress Fit) with PipeBloc EL/PWP pipe wraps

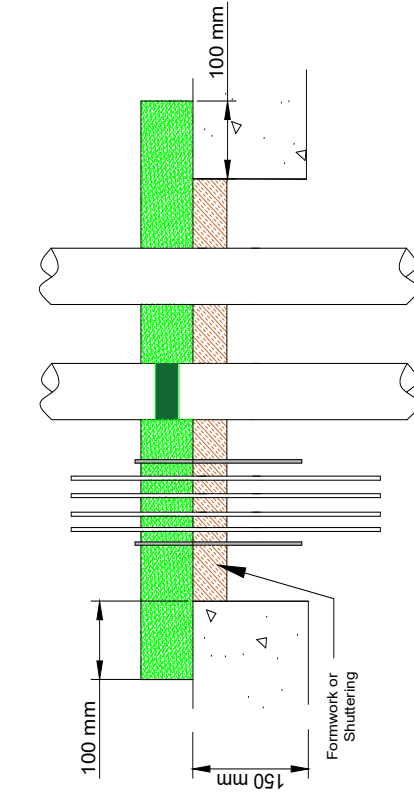

Silverseal HS Compound in rigid floors with dampers, copper/steel/metal. Combustible pipes with PipeBloc EL/PWP pipe wraps

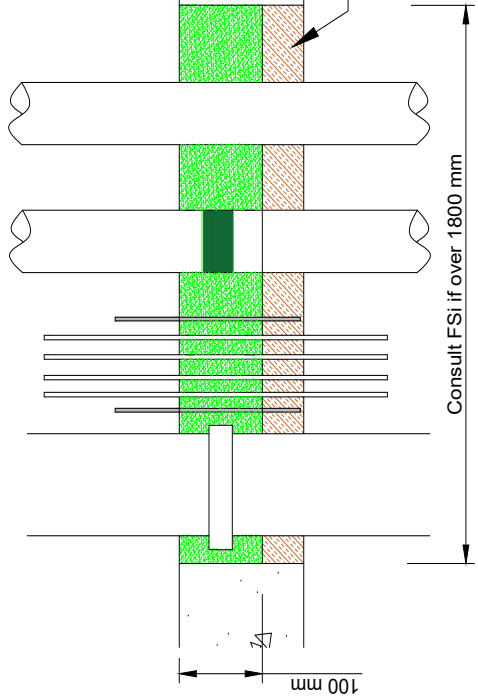

Silverseal Compound in rigid walls with copper/steel/metal pipes and cables. Combustible pipes with PipeBloc EL/PWP pipe wraps

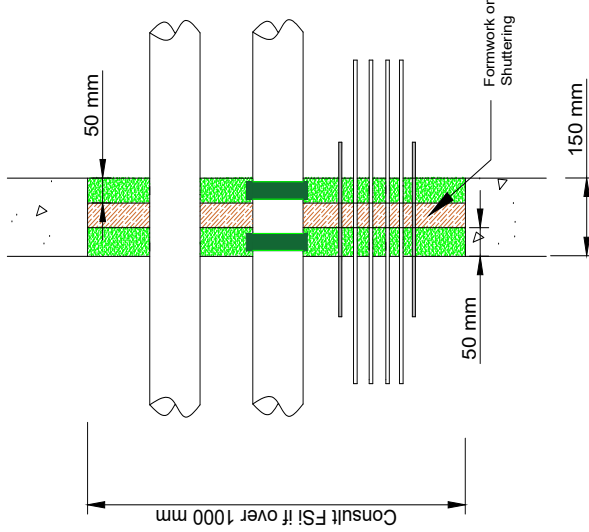

The information and recommendations given herein are believed to be correct at the time of writing. Any data referred to has been obtained from tests done under laboratory, or other controlled, conditions and it is the users' responsibility to use the data given in the light of conditions on site and taking account of the intended use of the products concerned. Whilst FSI Limited can give general guidance and advice, the nature of FSI products means that the ultimate responsibility for selecting the correct product for a particular application must lie with the customer. All descriptions and illustrations in this proposal/solution are intended for guidance only and shall not constitute a 'Sale by description' picture'. All dimensions given are nominal and FSI Limited may change the information, products and specifications from time to time for a variety of reasons, without prior notice. The information in this proposal/solution is provided 'as is' at the date specified.

Silverseal® Compound is a Gypsum based compound, used to reinstate the fire resistance performance of floor and wall constructions where they have been provided with apertures for the penetrations of single or multiple services. Silverseal® Compound is supplied as a dry material to be mixed with water to the required ratio prior to installation. When mixed the compound is self supporting in floor spans up to **700mm**. Silverseal® Compound is non-combustible and loading bearing.



## Key Product Points

- Can be used in rigid floors and walls with fire rated dampers.
- Rapid setting, zero shrinkage formulation - can be used as pourable or trowel grade, gas tight seals.
- Excellent workability ranging from stiff to pourable mix.
- Good load bearing performance in floor seals, \*No structural support required for seals up to 700mm spans. \*Silverseal® Compounds can be waterproofed. \*(Consult FSi for details)

## Certification and Approvals

- EN 1366-3
- EN 13501-2
- UL 1479
- ULus & ULc Listed
- 1121-CPR-JA5066, ETA 15/0281
- UL-EU-01025-CPR
- BREEAM International Approved
- BS6399-1 Loading for Buildings “Code of Practice for dead and applied loads”.

## KEY INSTALLATION POINTS

- For good adhesion the surfaces of the building elements shall be free of any dust or grease and may need to be primed. On good, clean virgin concrete & masonry, no priming required.
- Ensure that the aperture and services in question are tested with Silverseal® Compounds and the site conditions are within the application specification.

Silverseal® STD Compound can be mixed preferably by mechanical paddle or manually if required. Measure out the correct amount of clean water into a clean container to achieve the desired consistency.









**(Silverseal® STD Compound: water ratio):**  
**Pourable Mix ratio of 2 ½: 1    Trowelable Mix ratio of 3: 1**

Gradually add the Silverseal® STD Compound stirring continually. Continue mixing until the Silverseal® STD Compound is mixed to a smooth even consistency. Any spillage should be wiped up with a damp cloth before setting occurs as it may stain pipes and services. Mix only enough material sufficient for use within the recommended pot life (20-30 minutes). Pot life and set times will be reduced for lower water content and higher temperatures.

Installation should not be carried out when temperatures are above 35°C. Setting times are normally between 30 and 90 minutes. **Warning:** Do not attempt to extend working time by remixing with additional water once the compound has started to set, as this will interfere with the setting process. Always mix in clean buckets. Using dirty buckets containing remains of compound from earlier mixes may reduce working time.

Fit damming board/shuttering to bottom of opening. Damming materials must be able to support the wet weight of the compound under pouring conditions.

**Silverseal® STD Compound must be installed to the required minimum 100mm thickness.**

Tool Used For Installation	
	Dust pan and Brush
	Float
	Masking Tape
	Spatula
	Pencil and Ruler
	Plastic Sheet
	Tape Measure
	Mixing Tool
	Green Wipe



**Typical Layout FSi Silverseal® Fire Resistant Loadbearing Compounds in Rigid Floors and Walls.**

Silverseal HS Compound in rigid floors with dampers, copper/steel/metal. Combustible pipes with PipeBloc EL/PWP pipe wraps

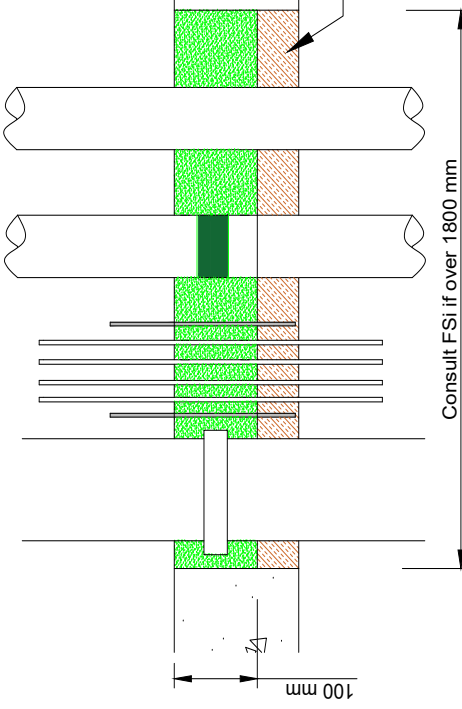

Silverseal STD Compound in rigid floors with copper/steel/metal. Combustible pipes with PipeBloc EL/PWP pipe wraps

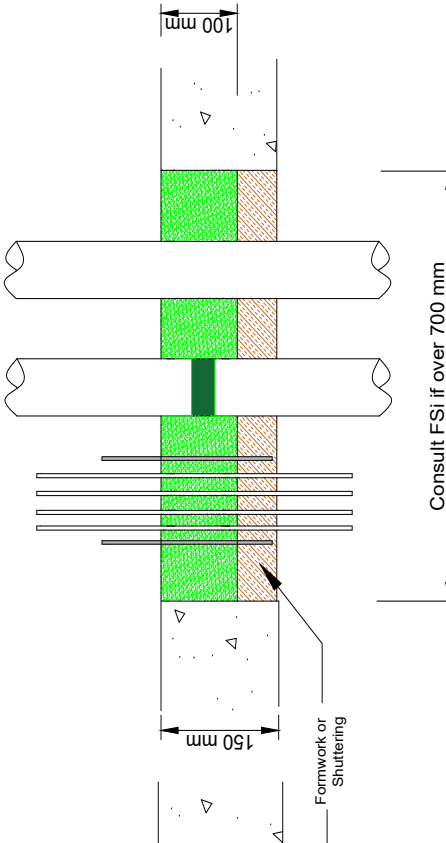

Silverseal Compound in rigid walls with copper/steel/metal pipes and cables. Combustible pipes with PipeBloc EL/PWP pipe wraps

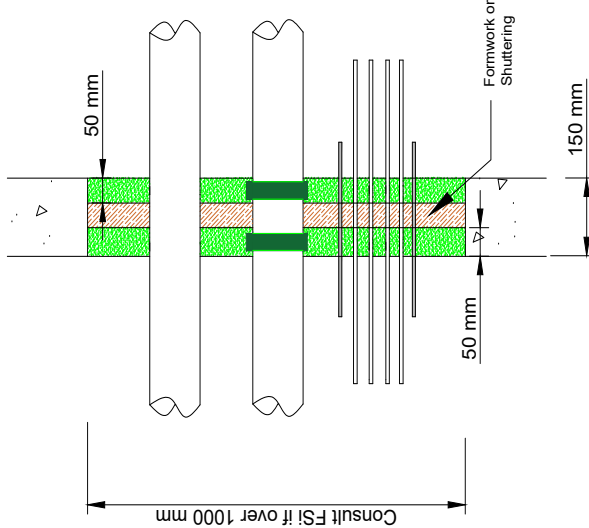

Silverseal HS Compound in rigid floors with copper/steel/metal pipes and cables. Combustible pipes (Pattress Fit) with PipeBloc EL/PWP pipe wraps

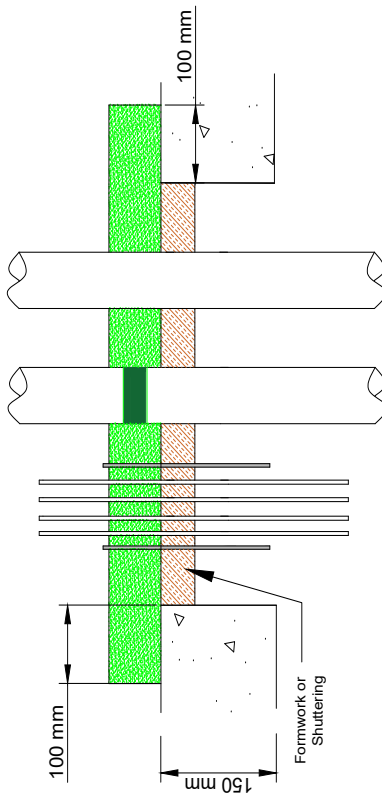

**Key Installation Guidance**

Formwork or shuttering is typically FSi Stopseal Batt or non combustible materials capable of supporting the wet weight of the compound which is approximately 130 kg/m<sup>2</sup> at 100mm thickness.

Formwork/Shuttering may involve creating a framing system. ALL Non combustible shuttering does not need to be removed.

For rigid floors the Silverseal must be poured at **100 mm depth** as a single pour. Loadbearing based on the flexural strength of the Silverseal Compounds 2.5k N/m<sup>2</sup> UDL

BS6399-1:  
Silverseal HS 2.0 N/mm<sup>2</sup>  
Silverseal STD 1.3 N/mm<sup>2</sup>  
For loadbearing calculations please contact FSi Technical Department.

FSi PipeBloc EL/PWP Pipe Wrap must be installed centrally within the Silverseal Compound where there are combustible pipes.

Insulation should be removed where it passes through the Silverseal Compounds. Contact FSi Technical team for guidance.

Consult FSi Technical Data Sheets for service size limitations and parameters.

Drawing Number / Name :  
**Typical Silverseal® Compounds Handbook**

Date : **April 2018**  
Scale : **N/A**

© FSi Limited. Please email us if you have any queries.

The information and recommendations given herein are believed to be correct at the time of writing. Any data referred to has been obtained from tests done under laboratory, or other controlled, conditions and it is the users' responsibility to use the data given in the light of conditions on site and taking account of the intended use of the products concerned. Whilst FSi Limited can give general guidance and advice, the nature of FSi products means that the ultimate responsibility for selecting the correct product for a particular application must lie with the customer. All descriptions and illustrations in this proposal/solution are intended for guidance only and shall not constitute a 'Sale by description' picture'. All dimensions given are nominal and FSi Limited may change the information, products and specifications from time to time for a variety of reasons, without prior notice. The information in this proposal/solution is provided 'as is' at the date specified.

Pyrocoustic® Trowel Grade Sealant is a water based acrylic sealant used to reinstate the fire resistance of wall and floor constructions where apertures are penetrated by single or multiple services and linear gap seals where wall and floor constructions abut. Pyrocoustic® Sealant has excellent acoustic and movement capabilities. Pyrocoustic® Sealant is extensively tested. The sealant can be trowel applied.



## Key Product Points

- Can be used in flexible walls, rigid walls and floors.
- Can be used in linear joints up to 50mm wide.
- Can be used in large service openings up to 490mm x 150mm.
- Can be used in with Metallic Pipes, Cables, Cable Bunches, Cable Trays and Cable Ladders.
- Causes no known effects to plastic pipes, plastic cables, sheathing or metallic components.
- For use in low movement joints as remains flexible.
- Halogen free, resists fungi and vermin.

## Certifications and Approvals

- EN 1366-3, EN 1366-4, EN 13501-1 and EN 13501-2
- EN 10140, EN 1026 and EN 717-1
- ASTM-E 1966 UL 2079 and ASTM D2369-10, LEED 2009-EQ041 SCAQMD
- CAN/UL 115-11 - ULus & ULc Listed
- 1121-CPR-JA5009, ETA 13/1069 & ETA 13/1070, UL-EU 0500-M1 and Certifire CF517
- SPEARS Approved and BREEAM International Approved
- UAE Certificate of Compliance

## KEY INSTALLATION POINTS

- For good adhesion the surfaces of the building elements shall be free of any dust or grease and may need to be primed. On good, clean virgin concrete & masonry, no priming required, though refer to substrate compatibility requirements.
- Ensure that the aperture and services in question are tested with Pyrocoustic® Trowel Grade and the site conditions are within the application specification.
- Consider the movement of the joint to be sealed. This should include thermal, wind pressures, settlement and differential movement of components.
- Consider the characteristics of the substrates as they affect the choice of sealant, i.e. how the surface finish may be affected by sealant compounds and the possibility of discolouration due to oil migration or staining.
- Consider the location and environment of the joint to be sealed. Exposure to temperature extremes, ultra violet light, radiation, chemical attack, standing water and vibration.
- Consider the characteristics of all available sealants for performance capabilities, hardness after weathering, movement capabilities in both extension and compression, adhesion properties and chemical resistance.

Tool Used For Installation	
	Dust pan and Brush
	Float
	Masking Tape
	Spatula
	Pencil and Ruler
	Plastic Sheet
	Tape Measure
	Green Wipe



PS Coating is an ablative coating applied to stone wool board to be used to reinstate the fire resistance performance of wall constructions where apertures exist with penetration of single or multiple services. PS Coating is an easy to apply highly viscous, or thick coating suitable to be applied by brush.



## Key Product Points

- Can be brush or trowel applied.
- Suitable for indoor use without additional environmental protection.
- Remains flexible between -5°C to +70°C.
- Easy to use fibre free coating.
- Suitable for large openings in walls systems such as in combination with Stopseal® Batt.

## Certification and Approvals

- EN 1366-3
- EN 13501-2
- EN 10140
- EN 1026
- 1121-CPR-JA5022, ETA 14/0004
- UL-EU-0517-CPR









## KEY INSTALLATION POINTS

- For good adhesion the surfaces of the building elements shall be free of any dust or grease and may need to be primed. On good, clean virgin concrete & masonry, no priming required, though refer to substrate compatibility requirements.
- Ensure that the aperture and services in question are tested with PS Coating and the site conditions are within the application specification.
- Upon installation make sure that you install the minimum 140kg/m<sup>3</sup> Stone Wool.
- Fit around all services effectively, brush or trowel over the stone wool ensuring all joints and junctions are fully covered to the minimum required PS Coating thickness.
- Ensure PS Coating Sealant is applied to a minimum:

**DFT (Dry Film Thickness) of 1mm (2.5mm Wet Film Thickness).**

*Stone wool minimum 140kg/m<sup>3</sup> maybe pre coated off site, applying some PS Coating to aid during installation. Ensure the correct thickness of PS Coating is applied after site installation.*

*Refer to Stopseal® Batt for specific installation information.*

Tool Used For Installation	
	Dust pan and Brush
	Float
	Masking Tape
	Spatula
	Pencil and Ruler
	Plastic Sheet
	Tape Measure
	Green Wipe



PenoPatch® are a pre-cut ablative discs designed for easy application around small cables and conduits where fire resistance is required or acoustic isolation and air permeability is a requirement. The PenoPatch discs are available in sizes 60mm diameter for 25mm x 25mm maximum apertures and 100mm diameter for 50mm x 50mm maximum apertures.



**Key Product Points**





- Can be used in flexible walls, rigid walls and floors.
- Can be used in service openings 25mm x 25mm and 50mm x 50mm.
- Can be used in conduits, Cables.
- Causes no known effects to plastic pipes, plastic cables, sheathing or metallic components.
- Contributes to Green Building.
- Non-setting compound.
- Highly flexible and water resistant.
- Halogen free, resists fungi and vermin.
- Maintains a fire and smoke barrier around small cables and conduits in flexible wall systems.
- High tack adhesion, pliable and mouldable with excellent self bonding properties.

**Certification and Approvals**

- EN 1366-3
- EN 13501-2
- EN 10140

**KEY INSTALLATION POINTS**

- For good adhesion the surfaces of the building elements shall be free of any dust or grease and may need to be primed. On good, clean virgin concrete & masonry, no priming required. Do not apply to damp surfaces.
- Ensure that the aperture and services in question are tested with Penopatch® and the site conditions are within the application specification.
- Penopatch® are fitted tightly and firmly around the service.
- Remove the lining paper from the back of the Penopatch.
- Ensure Penopatch® are tightly and firmly pressed against the substrate to create airtight seal.
- The Penopatch must be installed both sides of the service.

Tool Used For Installation	
	Dust pan and Brush
	Pencil and Ruler
	Tape Measure
	Green Wipe





Typical Layout FSi PenoPatch® in 100mm Flexible and Rigid Wall Systems



Typical PenoPatch (Face Fix) copper conduit in rigid and flexible walls

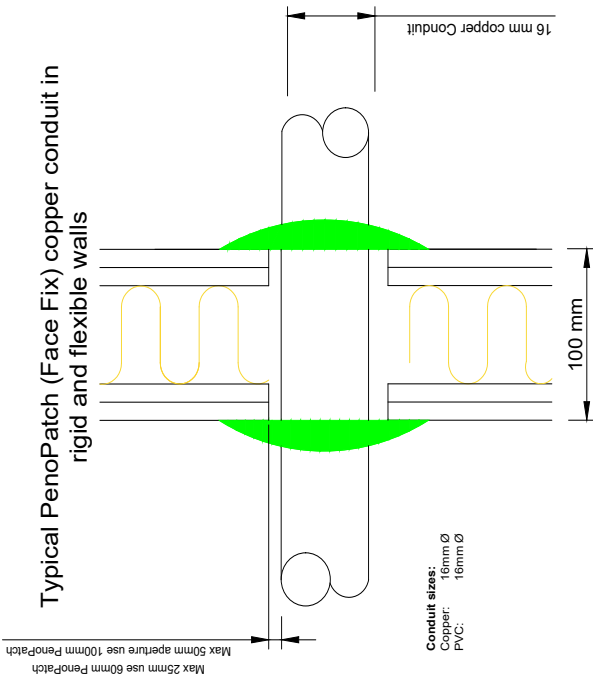

Typical PenoPatch (Face Fix) PVC conduit in rigid and flexible walls

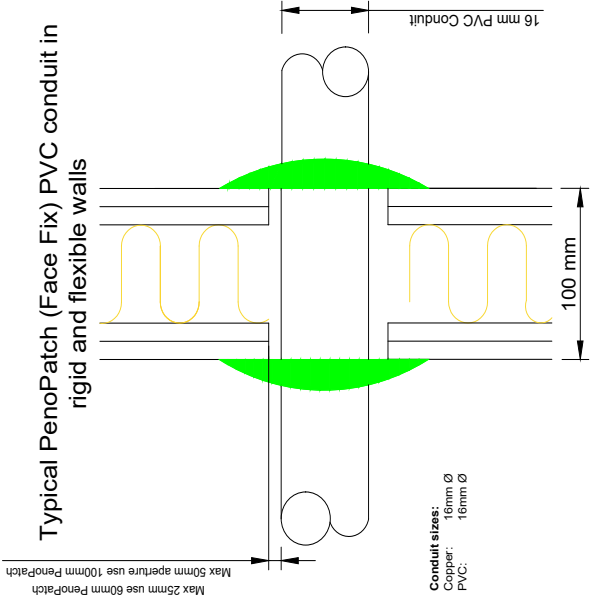

Typical PenoPatch (Face Fix) single cables in rigid and flexible walls

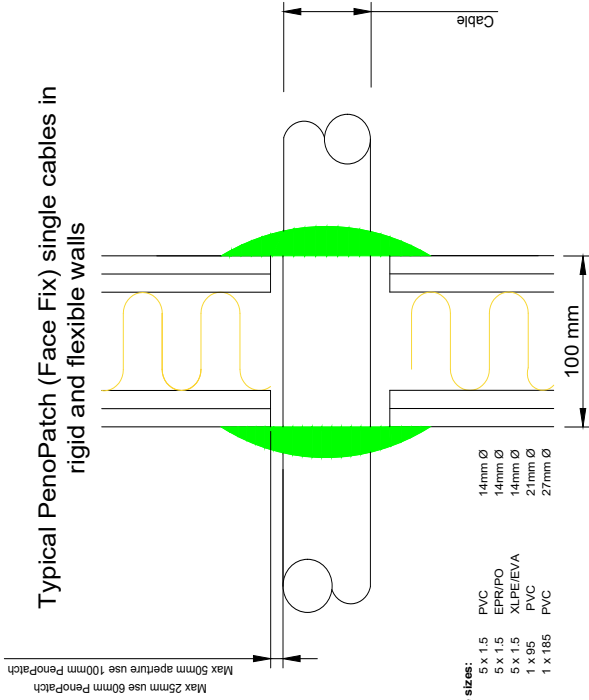

Typical PenoPatch (Face Fix) copper conduits, PVC conduits and single cable plan view rigid and flexible walls

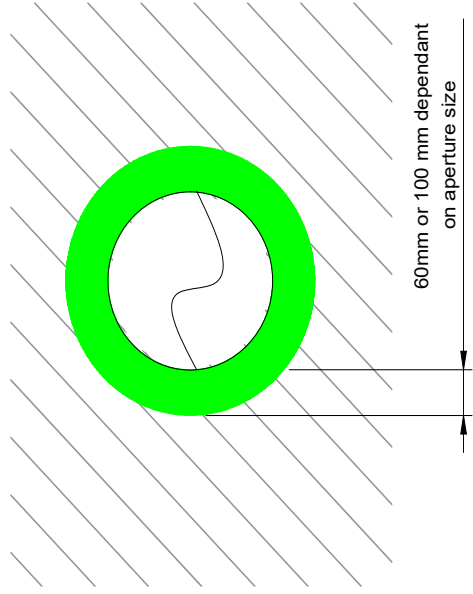

Key Installation Guidance

PenoPatch comes as a 60mm and 100mm disk size. Max 25 mm aperture around the conduit or pipe use 60mm PenoPatch. Max 50mm aperture around conduit/cable or pipe use 100mm PenoPatch

Place the PenoPatch around the copper, PVC conduit or single cable and press firmly creating an airtight seal around the pipe, cable or conduit. Ensure substrate is clean and dry and free from all contaminants.

This must be done on **both sides** of the wall system. Maximum void annulus between service and substrate is 50mm.

Consult FSi Technical Data Sheets for service sizes and parameters.

Drawing Number / Name :

Typical PenoPatch® Handbook

Date : April 2018

Scale : N/A

© FSi. Please don't copy this without our permission.

The information and recommendations given herein are believed to be correct at the time of writing. Any data referred to has been obtained from tests done under laboratory, or other controlled, conditions and it is the users' responsibility to use the data given in the light of conditions on site and taking account of the intended use of the products concerned. Whilst FSi Limited can give general guidance and advice, the nature of FSi products means that the ultimate responsibility for selecting the correct product for a particular application must lie with the customer. All descriptions and illustrations in this proposal/solution are intended for guidance only and shall not constitute a 'Sale by description' picture'. All dimensions given are nominal and FSi Limited may change the information, products and specifications from time to time for a variety of reasons, without prior notice. The information in this proposal/solution is provided 'as is' at the date specified.

NS Putty® Pads are a pre-cut ablative pads designed for easy application around single and double electrical sockets where fire resistance is required or acoustic isolation and air permeability is a requirement.



## Key Product Points





- Can be used in flexible walls, rigid walls and floors.
- Can be used in large service openings up to 250 x 150mm.
- Can be used in metallic Pipes, Cables, Cable Bunches, Cable Trays and Cable Ladders.
- Causes no known effects to plastic pipes, plastic cables, sheathing or metallic components.
- Contributes to Green Building.
- Non-setting compound.
- Highly flexible and water resistant.
- Halogen free, resists fungi and vermin.
- Maintains a fire and smoke barrier around sockets in flexible wall systems.
- High tack adhesion, pliable and mouldable with excellent self bonding properties.
- Preformed shape to fit most common socket boxes.

## Certification and Approvals

- EN 1366-3
- EN 13501-2
- EN 10140
- Certifire CF515

## KEY INSTALLATION POINTS

- For good adhesion the surfaces of the building elements shall be free of any dust or grease and may need to be primed. On good, clean virgin concrete & masonry, no priming required. Do not apply to damp surfaces.
- Ensure that the aperture and services in question are tested with NS Putty® Pads and the site conditions are within the application specification.
- NS Putty® Pads fit either internally or externally on the back of electrical boxes.
- Remove the lining paper from the pad.
- When using internally fold the pad to the shape of the box then press down firmly into the box working into the back and corners ensuring that NS Putty® Pads are firmly pressed into place. Press the edges of the pad together to form a continuous seal inside the box. Ensure the edges are brought firmly together to ensure complete coverage.
- When using externally, fold the pad around the back and sides of the socket overlapping onto the substrate and by pressing firmly to ensure that the NS Putty® Pads are in place. Press the edges of the pad together to form a continuous seal around the box. Ensure the edges are brought firmly together to ensure complete coverage.
- Ensure NS Putty® Pads are tightly moulded around electrical wiring passing into the socket or from out of the socket if external application.
- The NS Putty® Pads must be installed to ensure complete airtight seal.

Tool Used For Installation	
	Dust pan and Brush
	Pencil and Ruler
	Tape Measure
	Knife
	Green Wipe



Typical Layout FSi NS Putty® NS Putty Pads in Flexible Wall Systems



NS Putty Pad for electrical sockets flexible wall installed **over the back** of the electrical socket

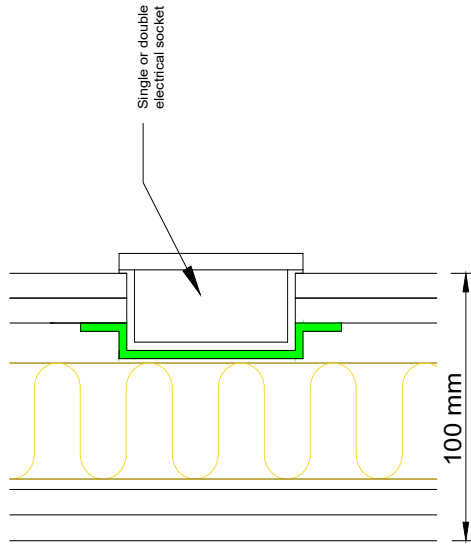

NS Putty Pad for electrical sockets flexible wall installed **internal (inside)** of electrical the socket

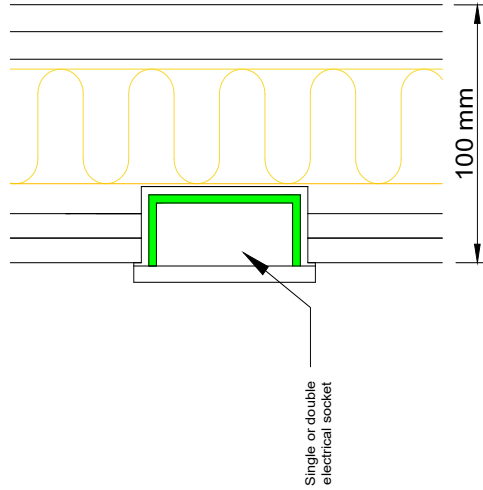

**Key Installation Guidance**

NS Putty Pads come on a roll ready to be cut to fit single or double gang sockets. NS Putty comes in a 1kg tub.

FSi NS Putty and NS Putty Pads must be installed by pressing the putty **tightly within or over the back** of the single or double gang socket. Can be used on back to back sockets in flexible wall systems.

NS Putty and NS Putty Pads must be tightly pressed around any cables that come into the box to create an airtight seal.

**Minimum thickness if NS Putty is used is 2mm.**

Consult FSi Technical Data Sheets for service sizes and parameters or FSi Technical team for scope outside parameters shown.

Drawing Number / Name :

Typical NS Putty® Putty Pads Handbook

Date : April 2018

Scale : N/A

© Copyright FSi Ltd 2018

© All Rights Reserved. You have the right to view this content.

NS Putty® is a non setting silicone designed to remain flexible allowing for thermal and mechanical movement of services around complete and irregular shapes through wall and floor where fire resistance must be maintained in the event of a fire



## Key Product Points

- Fire resistance tested in flexible walls, rigid walls and floors.
- Tested in large service openings up to 250mm x 150mm.
- Tested with Metallic Pipes, Cables, Cable Bunches, Cable Trays and Cable Ladders.
- Causes no known effects to plastic pipes, plastic cables, sheathing or metallic components.
- Contributes to Green Building.
- Non-setting compound.
- Highly flexible and water resistant.
- Halogen free, resists fungi and vermin.
- Maintains a fire and smoke barrier around sockets in flexible wall systems.
- High tack adhesion, pliable and mouldable with excellent self bonding properties.







## Certification and Approvals

- EN 1366-3
- EN 10140
- EN 13141-1
- Certifire CF515

## KEY INSTALLATION POINTS

- For good adhesion the surfaces of the building elements shall be free of any dust or grease and may need to be primed. On good, clean virgin concrete & masonry, no priming required. Do not apply to damp surfaces.
- Ensure that the aperture and services in question are tested with NS Putty® and the site conditions are within the application specification.
- NS Putty® fits either internally or externally on the back of electrical boxes.
- When using internally mould the pad to the shape of the box then press down firmly into the box working into the back and corners ensuring that NS Putty® is firmly pressed into place. Press the edges of the pad together to form a continuous seal inside the box. Ensure the edges are brought firmly together to ensure complete coverage.
- When using externally, mould the pad around the back and sides of the socket overlapping onto the substrate and by pressing firmly to ensure that the NS Putty® are in place. Press the edges of the pad together to form a continuous seal around the box. Ensure the edges are brought firmly together to ensure complete coverage.
- Ensure NS Putty® is installed minimum 2mm thickness.
- Ensure NS Putty® is tightly moulded around electrical wiring passing into the socket or from out of the socket if external application.
- The NS Putty® must be installed to ensure complete airtight seal.

### Tool Used For Installation

	Dust pan and Brush
	Spatula
	Pencil and Ruler
	Plastic Sheet
	Tape Measure
	Green Wipe



**Typical Layout FSi NS Putty® NS Putty Pads and PenoPatch® in 100mm Flexible Wall Systems**

NS Putty Pad for electrical sockets flexible wall installed **over the back** of the electrical socket

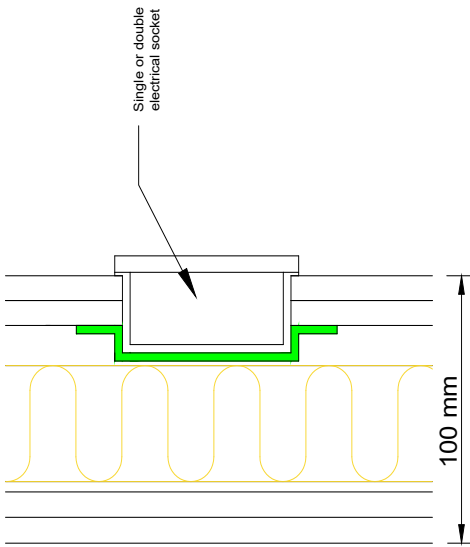

NS Putty Pad for electrical sockets flexible wall installed **internal** of electrical the socket

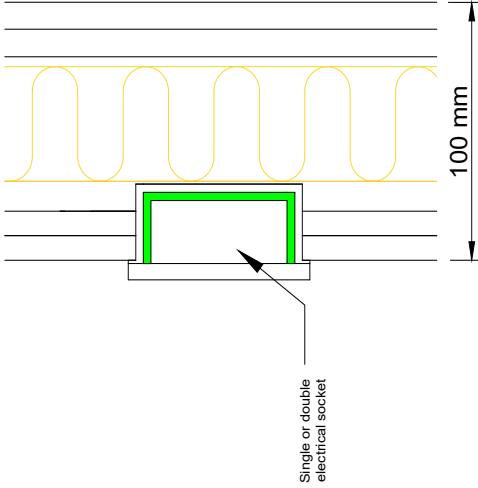

Typical PenoPatch (Face Fix) steel/metal and PVC conduit including individual cables

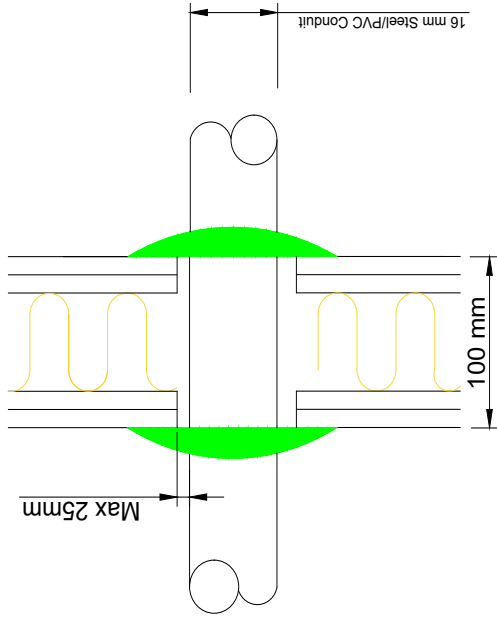

Typical PenoPatch (Face Fix) copper/steel/metal pipes and individual cables and conduits plan view

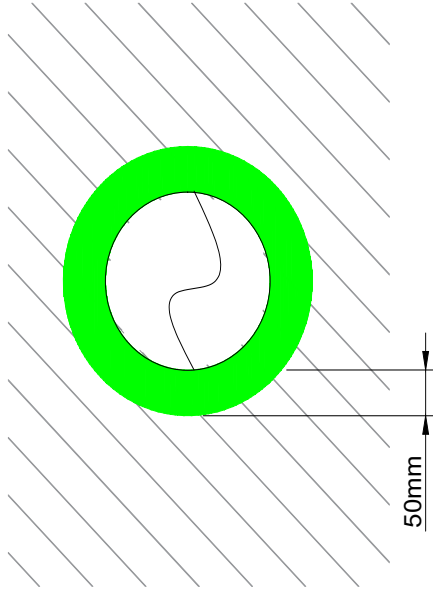

**Key Installation Guidance**

FSi NS Putty and NS Putty Pads and must be installed by pressing the putty **tightly within or over the back** of the single or double gang socket. Refer to Technical Data Sheet for limitations.

NS Putty and Putty Pads must be tightly pressed around any cables that come into the box to create an **airtight seal. Minimum thickness if NS putty is used is 2mm.** Consult FSi Technical Data Sheets for electrical socket sizes and parameters.

**PenoPatch:**

For single small un-insulated metal and steel pipes or single cables including 16mm PVC plastic conduits. Place the PenoPatch around the service and press firmly creating an airtight seal.

This must be done on **both sides** of the substrate. Maximum annulus between service and substrate is 25mm.

Consult FSi Technical Data Sheets for service sizes and parameters.

Drawing Number / Name :

Typical NS Putty® Putty Pads and PenoPatch® Handbook

Date : April 2018

Scale : N/A

© FSi. Please don't copy this without our consent.

S-Line® Fire Pillows are an ideal product to create a temporary or permanent fire barrier around many types of services to prevent the passage of fire through a compartment wall or floor, especially suitable where services are continuously being changed or replaced. S-Line® Fire Pillows are filled with organic fillers and reactive intumescent additives in a PU glass cloth case.



## Key Product Points

- Can be used in rigid walls & floors.
- Can be used with Metallic Pipes, Cables, Cable Bunches, Cable Trays and Cable Ladders.
- Reaction Temperature 180°C.
- High Expansion Ratio.
- Remains flexible between -20°C to +130°C.
- Water resistant lining.
- Suitable for locations up to 1m<sup>2</sup>.
- Non-combustible and non-toxic.
- Ease of installation and long life.

## Certifications and Approvals





- EN 1366-3
- EN 13501-2
- EN 10140
- EN 1026
- EN ISO 13934-1
- EN ISO 13935-1
- BS 476
- 1121-CPR-JA5008, ETA 13/1056
- UL-EU-00640-CPR
- Certifire CF514

## KEY INSTALLATION POINTS

- For good adhesion the surfaces of the building elements shall be free of any dust or grease and may need to be primed. On good, clean virgin concrete & masonry, no priming required.
- Ensure that the aperture and services in question are tested with S-Line® Pillows and the site conditions are within the application specification.
- Upon installation make sure that you install the S-Line® Fire Pillow length ways to the recommended installation method for the service you are installing around.
- Install the S-Line® Fire Pillows in such a way that all joints are staggered in each layer until you have filled all gaps within the wall. Pack pillows tightly into the opening around the services to a minimum depth of 150mm. Always ensure that large voids are completely filled and S-Line® pillows are installed in a manner that ensures a tight compression fit.
- Fill in any gaps with the smaller S-Line® pillows until there are no gaps. Always ensure that large voids are completely filled and fire pillows are installed in a manner that ensures a tight compression fit.

### For floor

- Install a 5mm mild steel mesh securely fastened to rigid floor.
- Arrange S-Line® Pillows in such a manner that they fully fill the penetration voids to a minimum depth of 150mm on the mesh.
- When cable trunking passes through the seal ensure that the inside is filled with S-Line® Sausage Pillows.

Tool Used For Installation	
	Dust pan and Brush
	Pencil and Ruler
	Tape Measure
	Green Wipe



Typical Layout FSI S-Line® Pillows in Rigid Wall and Floor Systems

Typical plan view S-Line Pillows in rigid wall system with copper/steel/metal pipes, cables and cable trays.

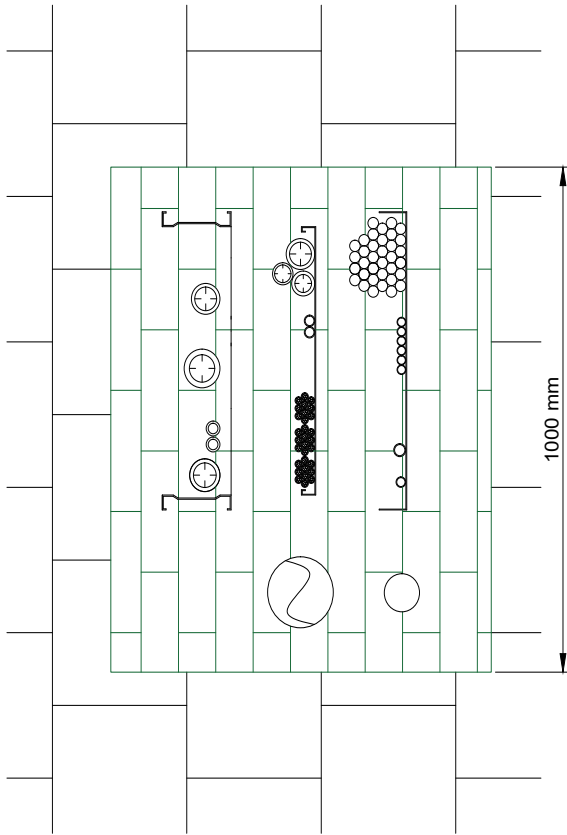

Typical section view S-Line Pillows in rigid wall system with copper/steel/metal pipes, cables and cable trays.

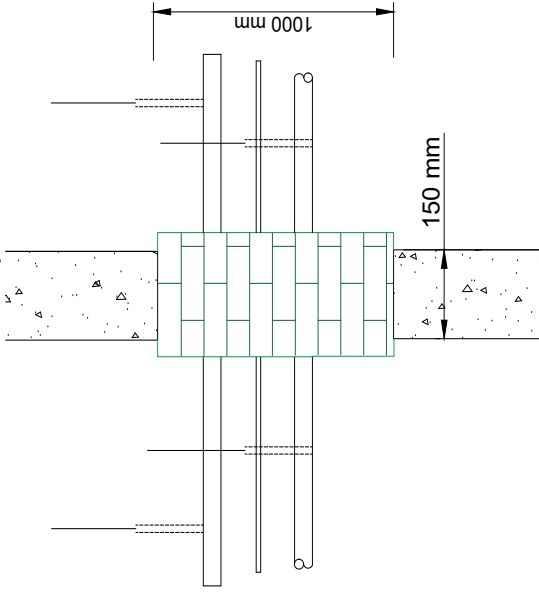

Typical section view S-Line Pillows in rigid floor system with cables and cable trays supported on mechanically fixed mesh

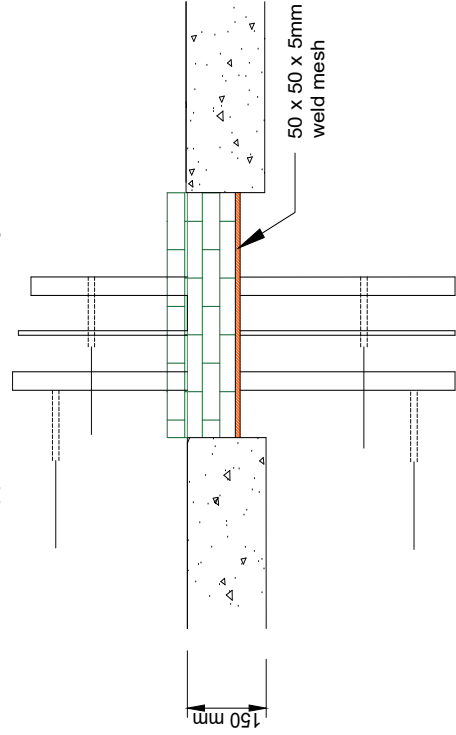

Westminster Industrial Estate,  
Tottenham, London, N16 9JG, UK  
TEL: +44 (0)1832 515150  
www.fsiid.com

**Key Installation Guidance**

FSI S-Line Pillows must be installed into the opening and around all the services.

Refer to FSI Technical Data Sheet for service size limitations and parameters.

FSI S-Line Pillows installed in Floors **require steel mesh** (50mm by 50mm by 5mm weld mesh). It must be mechanically fixed to either the soffit of the floor or within the reveal of the aperture via vertical returns at the edges of the mesh.

The S-Line pillows **must be tightly packed** into the opening and around the services.

For requirements beyond the Technical data Sheets consult FSI Technical Team.

Drawing Number/ Name :  
**Typical S-Line® Pillow Handbook**  
Date :  
**April 2018**  
Scale :  
**N/A**

Pass-It® Transit System is a pre-assembled, multi layered reactive intumescent device encased in a 2 part powder coated steel shell. It is designed to prevent the passage of fire between compartment walls, whilst still allowing for the easy installation and removal of services without destruction of the seal. There are a wide range of different sizes available depending on the number and size of the services required to penetrate. It can be formed into a modular grid or linear format, allowing an easy route for services to travel.



## Key Product Points









- Can be used in flexible and rigid walls
- Easy installation of services.
- Instant entry / re-entry without damaging penetration seal.
- Up to 2 hours FR - E120 EI 60.
- Can be used with cables and pipes.
- Many different size combinations.
- Can be module fixed together.
- Superior level of sustainability.
- Ideal for Historical Building Upgrades or new build future planning.

## Certifications and Approvals

- EN1366-3
- AS 1530-4
- Certifire CF5237

## KEY INSTALLATION POINTS

- For good adhesion the surfaces of the building elements shall be free of any dust or grease and may need to be primed. On good, clean virgin concrete & masonry, no priming required.
- Ensure that the aperture and services in question are tested with Pass-It® Transit System and the site conditions are within the application specification.
- Ensuring that the Pass-It® Transit System is the correct size for the aperture.
- Install the Pass-It® Transit System into place or where existing build limits installation the Pass-It® Transit System can be de-constructed and wrapped around the services to be re-constructed and then installed into the aperture.
- Pass-It® Transit System can then be either sealed with Pyrocoustic® Sealant or Pyrolastic Sealant alternatively it can be fixed using the fixing brackets attached.

Tool Used For Installation	
	Cartridge Gun
	Dust pan and Brush
	Masking Tape
	Spatula
	Pencil and Ruler
	Tape Measure
	Knife
	Fixings
	Green Wipe



Typical Layout FSi Pass-It® Transit System, Service Management 100mm Flexible and Rigid Walls Systems

Typical section view Pass-It Transit System fitted metal/steel/copper pipes, cables and cable trays in flexible and rigid wall

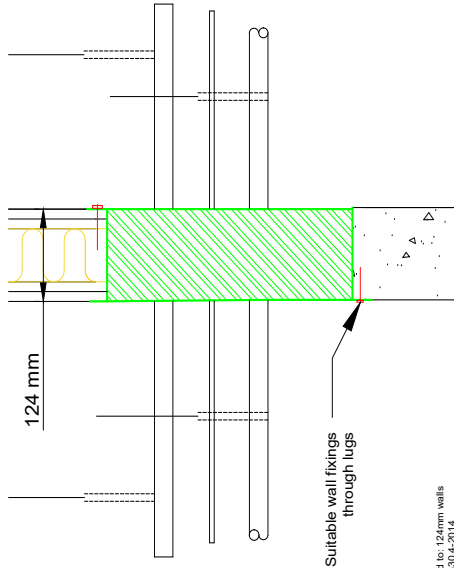

Tested to: 124mm walls  
AS 1530.4-2014

Typical plan view Pass-It Transit System fitted metal/steel/copper pipes, cables and cable trays in flexible and rigid wall

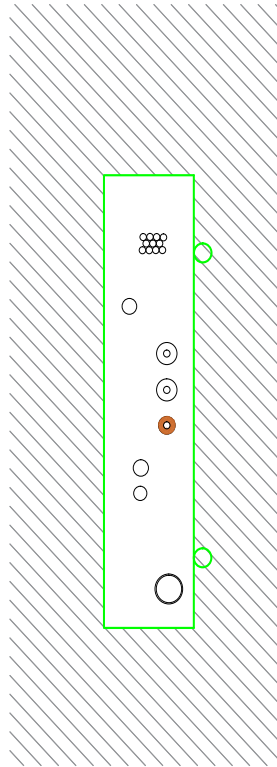

Typical section view Pass-It Transit System fitted to soffit metal/steel/copper pipes, cables and cable trays in flexible and rigid wall

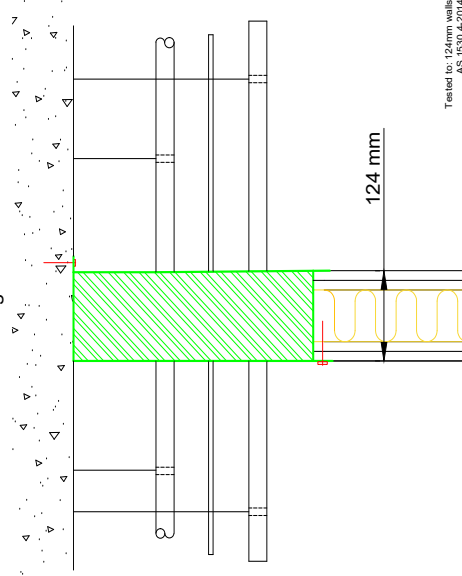

Tested to: 124mm walls  
AS 1530.4-2014

Typical plan view Pass-It Transit System soffit fitted metal/steel/copper pipes, cables and cable trays in flexible and rigid wall

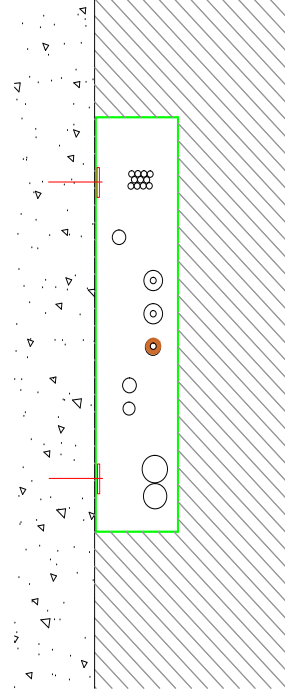

Key Installation Guidance

FSi Pass-It Transit System must be installed using available lugs as a mechanical fix to the substrate. Where there is a "gap" around the Pass-It system (no more than 10mm) seal this gap using Pyrocoustic Sealant.

Use suitable steel anchor fixings for concrete or blockwork. Use minimum 70mm Steel wood screws and penny washers for flexible wall systems.

Refer to the Pass-It Technical Data Sheet for size and service limitations and parameters for walls.

For 100mm flexible wall systems see Technical Data Sheet for service limitations.

For sizes or services not shown in the Technical Data Sheet consult FSi Technical Team for advice.

Drawing Number/ Name :  
Typical Pass-It® Handbook

Date :  
April 2018

Scale:  
N/A

© 2018 FSi Ltd. All rights reserved.

The information and recommendations given herein are believed to be correct at the time of writing. Any data referred to has been obtained from tests done under laboratory, or other controlled, conditions and it is the users' responsibility to use the data given in the light of conditions on site and taking account of the intended use of the products concerned. Whilst FSi Limited can give general guidance and advice, the nature of FSi products means that the ultimate responsibility for selecting the correct product for a particular application must lie with the customer. All descriptions and illustrations in this proposal/solution are intended for guidance only and shall not constitute a "Sale by description" picture". All dimensions given are nominal and FSi Limited may change the information, products and specifications from time to time for a variety of reasons, without prior notice. The information in this proposal/solution is provided "as is" at the date specified.

**FSi making the hard work easy**

FSi Ltd has now launched our new wet wipe GREEN WIPE, aimed for the hard workers of the world.

FSi Green Wipes have been specially formulated to provide a heavy duty cleaning solution, removing: Sealants, paints and Coatings, Adhesives, Oil, Foams, Grease and Other stains.

Green Wipes can be used to remove residue from your hands as well as tools and general surfaces. Green Wipes have been designed for professionals in a multiple of trades, including: Sealant applicators, DIY, Plumbers, Electricians, Joiners, Painters and Decorators, Window Installers, Engineers.

Heavy duty hand wipes are used by lots of professional tradesmen and have become part of their everyday 'toolkit'. Their flexibility of use and easy to handle nature ensure they are an everyday used item. Green Wipes are fully compliant with EU Cosmetic Legislation, with strong antibacterial additives.

Green Wipes are heavy duty, provided with a textured finish to assist in loosening dirt, grit and residue from your hands, surfaces and tools.

Making The Hard Work Easy!

FSi's NEW wet wipe product:

**GREEN WIPE**



Contains  
100  
Wipes

"Great multi purpose wipe, cleans everything!"

- On-site User



**FIRE STOPPING & COMPARTMENTATION SYSTEMS**

# Linear Joint Seals:

**Pyrofusion Hybrid Sealant<sup>®</sup>**

**Pyrocoustic Sealant<sup>®</sup>**

**Pyropro LST<sup>®</sup>**

**Pyrolastic Silicone<sup>®</sup>**

**Flexi Coat<sup>®</sup>**

**Stopseal Ablative Spray Coating<sup>®</sup>**

**Stopseal Linear Gap Seal<sup>®</sup>**

# Pyrocoustic® Sealant

Pyrocoustic® Sealant is a water based acrylic sealant used to reinstate the fire resistance of wall and floor constructions where apertures are penetrated by multiple services and linear gap seals where wall and floor constructions abut. Pyrocoustic® Sealant is extensively tested for global requirements, it is supplied in 310ml cartridges or 600ml foils.



## Key Product Points

- Fire resistance tested in flexible walls, rigid walls and floors.
- Tested in Linear Joints up to 50mm wide.
- Tested in large service openings up to 490mm x 150mm.
- Tested with Metallic Pipes, Cables, Cable Bunches, Cable Trays and Cable Ladders.
- Causes no known effects to plastic pipes, plastic cables, sheathing or metallic components.
- For use in low movement joints, remains flexible.
- Halogen free, resists fungi and vermin.
- Shelf Life 18 months.











## Certifications and Approvals

- EN 1366-3 and EN 1366-4
- EN 13501-1 and EN 13501-2
- EN 10140, EN 1026 and EN 717-1
- ASTM-E 1966 UL 2079 and ASTM D2369-10
- LEED 2009-EQ041 SCAQMD
- CAN/UL 115-11 - ULus & ULc Listed
- 1121-CPR-JA5009, ETA 13/1069 & ETA 13/1070
- UL-EU 0500-M1 and Certifire CF517
- SPEARS Approved and BREEAM International Approved
- UAE Certificate of Compliance

## KEY INSTALLATION POINTS

- For good adhesion the surfaces of the building elements shall be free of any dust or grease and may need to be primed. On good, clean virgin concrete & masonry, no priming required, though refer to substrate compatibility requirements.
- Ensure that the aperture and services in question are tested with Pyrocoustic® Sealant and the site conditions are within the application specification. An annular space needs to be present around the service to apply sufficient installation depth.
- Consider the movement of the joint to be sealed. This should include thermal, wind pressures, settlement and differential movement of components.
- Consider the characteristics of the substrates as they affect the choice of sealant, i.e. how the surface finish may be affected by sealant compounds and the possibility of discolouration due to oil migration or staining.
- Consider the location and environment of the joint to be sealed. Exposure to temperature extremes, ultra violet light, radiation, chemical attack, standing water and vibration.
- Consider the characteristics of all available sealants for performance capabilities, hardness after weathering, movement capabilities in both extension and compression, adhesion properties and chemical resistance.
- Adequate space and accessibility should be provided for applying and tooling the sealant. Mineral wool (min. 80kg/m³) or PE backing rod where required can be used as backing materials, though the Pyrocoustic® Sealant should be installed correctly to achieve the performance needed.
- Seal ratio at 2:1 (50 mm gap width x 25 mm depth etc).
- Material Required: To determine quantity of sealant required, calculate as follows (in mm):  

$$\text{Gap width} \times \text{Depth} \times \text{Total length} \div 310 = \text{Number of Cartridges}$$
*(Remember to double to get both sides of the seal if total length is measured singly)*

Tool Used For Installation	
	Cartridge Gun
	Dust pan and Brush
	Float
	Masking Tape
	Spatula
	Pencil and Ruler
	Plastic Sheet
	Tape Measure
	Knife
	Green Wipe



Typical Layout FSI Pyrocoustic® Acrylic Sealant in Rigid Floors, Rigid and Flexible and Wall Systems

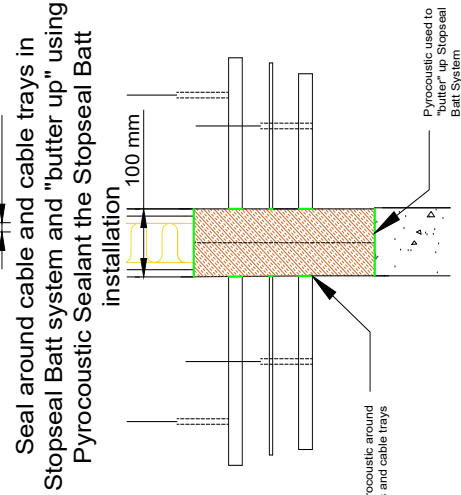
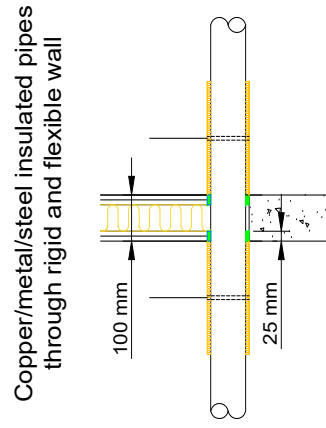
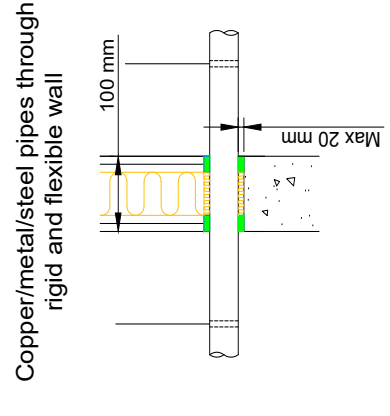
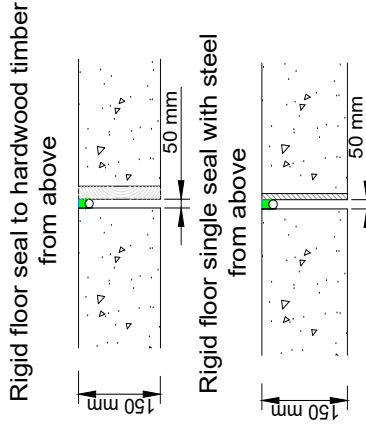
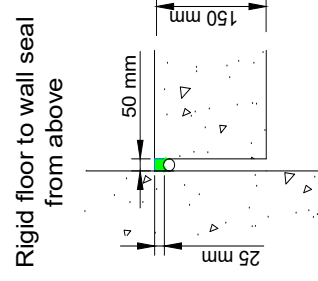
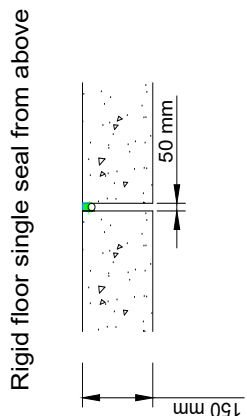
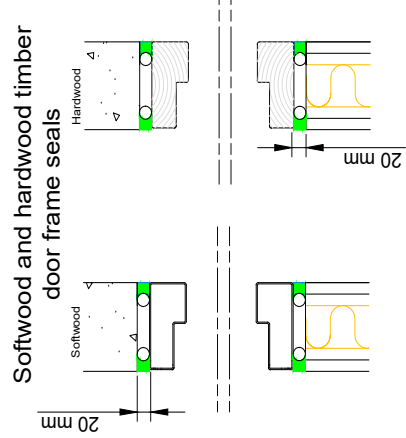
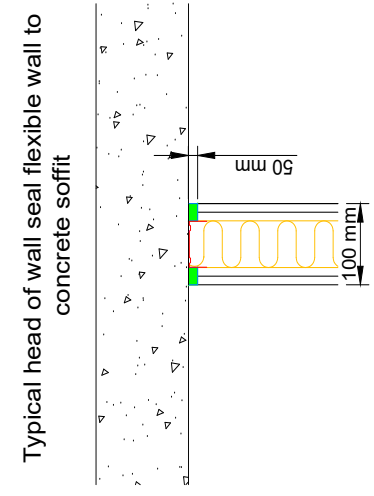
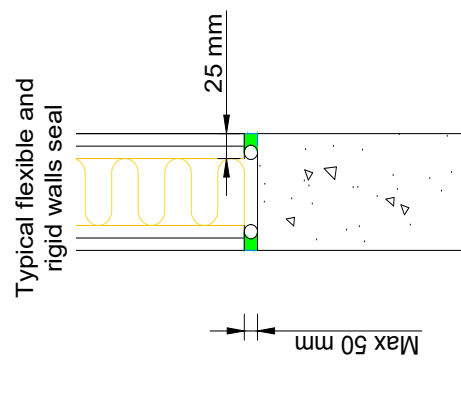

Key Installation Guidance

- Maximum Linear Joint GAP size is 50mm.
- FSI Pyrocoustic must be installed to a minimum depth. Typically the depth is 2:1 width to depth ratio (Example: 50mm gap, 25mm depth, 30mm gap, 15mm depth)
- Backing material Polyethylene backing rod should be used to ensure correct formation of the seal and ensuring correct depth.
- Ensure all surfaces are clean and free from dirt and contamination before application.
- Refer to Technical Data Sheet for compatibility requirements when using Pyrocoustic Sealant against any substrate.
- Movement:** Pyrocoustic has been assessed for movement capability for lateral and shear movement up to ± 25%. Contact FSI Technical Department for information.
- For service size limitations and parameters consult our Technical data Sheets.

Drawing Number/ Name :	Typical Pyrocoustic® Handbook
Date :	April 2018
Scale :	N/A

© Copyright FSI Ltd 2018

The information and recommendations given herein are believed to be correct at the time of writing. Any data referred to has been obtained from tests done under laboratory, or other controlled, conditions and it is the users' responsibility to use the data given in the light of conditions on site and taking account of the intended use of the products concerned. Whilst FSI Limited can give general guidance and advice, the nature of FSI products means that the ultimate responsibility for selecting the correct product for a particular application must lie with the customer. All descriptions and illustrations in this proposal/solution are intended for guidance only and shall not constitute a 'sale by description' picture'. All dimensions given are nominal and FSI Limited may change the information, products and specifications from time to time for a variety of reasons, without prior notice. The information in this proposal/solution is provided 'as is' at the date specified.

Pyropro® LST has been designed to be used in tunnel systems and is approved for use on the London Underground Network.

Pyropro® LST is a water based, acrylic sealant used to reinstate the fire resistance of wall and floor constructions where apertures are penetrated by multiple services and linear gap joints where wall and floor constructions abut.



### Key Product Points

- Fire resistance tested in flexible walls, rigid walls and floors.
- Tested in Linear Joints up to 50mm wide.
- Tested in large service openings up to 490mm x 150mm.
- Tested with Metallic Pipes, Cables, Cable Bunches, Cable Trays and Cable Ladders.
- Causes no known effects to plastic pipes, plastic cables, sheathing or metallic components.
- For use in low movement joints, remains flexible.
- Halogen free, resists fungi and vermin.
- Shelf Life 18 months.











### Certifications and Approvals

- LUL Approved product
- EN 1366-3
- EN 1366-4
- EN 13501-2
- EN 10140
- EN 1026
- BS 476 20&22
- 1121-CPR-JA5090, ETA 15/0697 & 15/0698
- Certifire CF517
- Mechanical Adhesion, Tensile testing & Shore Hardness to ISO 9046:2005, ISO 8339:2005 & ISO 7619-1:2011.

### KEY INSTALLATION POINTS

- For good adhesion the surfaces of the building elements shall be free of any dust or grease and may need to be primed. On good, clean virgin concrete & masonry, no priming required, though refer to substrate compatibility requirements.
- Ensure that the aperture and services in question are tested with Pyropro® LST and the site conditions are within the application specification. An annular space needs to be present around the service to apply sufficient installation depth.
- Consider the movement of the joint to be sealed. This should include thermal, wind pressures, settlement and differential movement of components.
- Consider the characteristics of the substrates as they affect the choice of sealant, i.e. how the surface finish may be affected by sealant compounds and the possibility of discolouration due to oil migration or staining.
- Consider the location and environment of the joint to be sealed. Exposure to temperature extremes, ultra violet light, radiation, chemical attack, standing water and vibration.
- Consider the characteristics of all available sealants for performance capabilities, hardness after weathering, movement capabilities in both extension and compression, adhesion properties and chemical resistance.
- Adequate space and accessibility should be provided for applying and tooling the sealant. Mineral wool (min. 80kg/m<sup>3</sup>) or PE backing rod where required can be used as backing materials, though the Pyropro® LST should be installed correctly to achieve the performance needed.

#### Tool Used For Installation

	Cartridge Gun
	Dust pan and Brush
	Float
	Masking Tape
	Spatula
	Pencil and Ruler
	Plastic Sheet
	Tape Measure
	Knife
	Green Wipe





Typical Layout Fsi PyroPro® LST in 150 mm Rigid Floors and Walls Systems

Rigid walls seals polyethylene backing

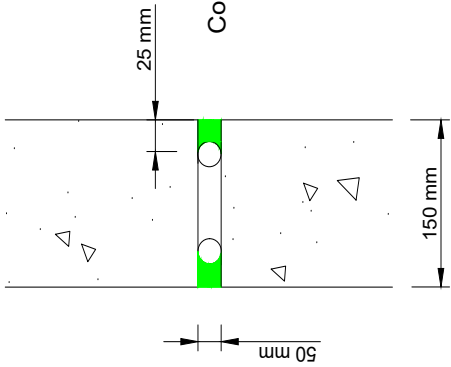

Concrete/Blockwork rigid wall seals stonewool backing

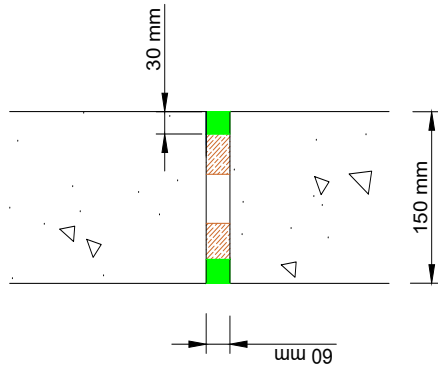

Concrete/Blockwork rigid wall seals polyethylene backing

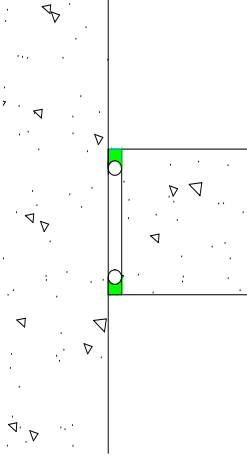

Rigid floor to rigid wall seal polyethylene backing

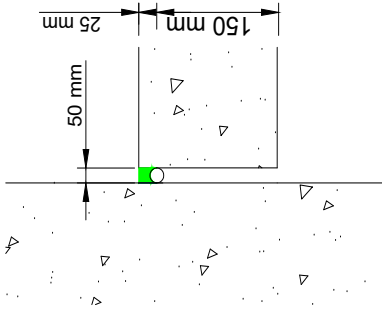

Rigid floor seal with stonewool backing material

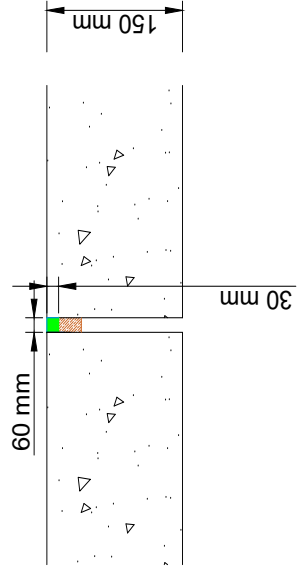

Rigid floor seal with polyethylene backing rod

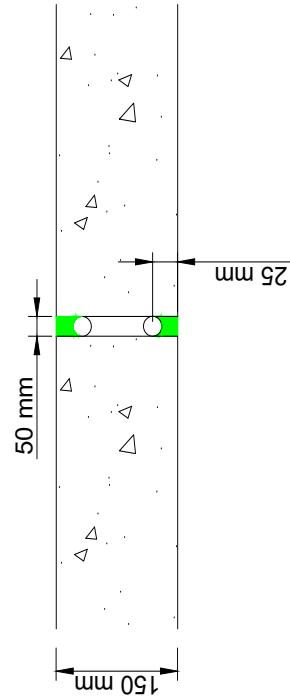

Key Installation Guidance

Maximum Linear Joint GAP size is 50mm.

FSI PyroPro LST must be installed to a minimum depth. Install PyroPro LST at a minimum 2:1 width to depth ratio. (eg. 30mm gap 15mm depth both sides of the void/joint)

Backing material fit under compression and suitable for gap/joint/void size or use 45kg/m<sup>3</sup> density stonewool.

Ensure all surfaces are clean and free from dirt and contamination before application. Refer to Technical Data Sheet for compatibility requirements.

For other substrates or uses consult our Technical data Sheets or contact FSI Technical Team for specific guidance.

Drawing Number/ Name : Typical LST® Handbook

Date : April 2018

Scale : N/A

© Copyright FSI Ltd 2018

© FSI. Please don't copy or reuse this content without our permission.

The information and recommendations given herein are believed to be correct at the time of writing. Any data referred to has been obtained from tests done under laboratory, or other controlled, conditions and it is the users' responsibility to use the data given in the light of conditions on site and taking account of the intended use of the products concerned. Whilst FSI Limited can give general guidance and advice, the nature of FSI products means that the ultimate responsibility for selecting the correct product for a particular application must lie with the customer. All descriptions and illustrations in this proposal/solution are intended for guidance only and shall not constitute a 'Sale by description / picture'. All dimensions given are nominal and FSI Limited may change the information, products and specifications from time to time for a variety of reasons, without prior notice. The information in this proposal/solution is provided 'as is' at the date specified.

Pyrolastic® Fire Resistant Silicone is used to seal linear joints in floor and wall constructions to reinstate the fire resistance performance. Pyrolastic® Fire Resistant Silicone has excellent movement and weathering capabilities, can be applied internally and externally, is supplied in 310ml cartridges and 600ml foils in various colours.



## Key Product Points











- Fire resistant up to 4 hours in both horizontal and vertical joints.
- Can be used in joints up to 60mm wide.
- Non-slump, easy to apply and tool off .
- No priming required for most substrates.
- Contributes to Green Building.
- Highly flexible and waterproof.

## KEY INSTALLATION POINTS

- For good adhesion the surfaces of the building elements shall be free of any dust or grease and may need to be primed. On good, clean virgin concrete & masonry, no priming required, though refer to substrate compatibility requirements.
- Ensure that the aperture and services in question are tested with Pyrolastic® Silicone and the site conditions are within the application specification. An annular space needs to be present around the service to apply sufficient installation depth.
- Consider the movement of the joint to be sealed. This should include thermal, wind pressures, settlement and differential movement of components.
- Consider the characteristics of the substrates as they affect the choice of sealant, i.e. how the surface finish may be affected by sealant compounds and the possibility of discolouration due to oil migration or staining.
- Consider the location and environment of the joint to be sealed. Exposure to temperature extremes, ultra violet light, radiation, chemical attack, standing water and vibration.
- Consider the characteristics of all available sealants for performance capabilities, hardness after weathering, movement capabilities in both extension and compression, adhesion properties and chemical resistance.
- Adequate space and accessibility should be provided for applying and tooling the sealant. Mineral wool (min. 80kg/m³) or PE backing rod where required can be used as backing materials, though the Pyrolastic® Silicone should be installed correctly to achieve the performance needed.

## Certifications and Approvals

- EN1366-4
- EN13501-2
- 1121-CPR-JA5064, ETA 15/0179
- Certifire CF511

Tool Used For Installation	
	Cartridge Gun
	Dust pan and Brush
	Float
	Masking Tape
	Spatula
	Pencil and Ruler
	Plastic Sheet
	Tape Measure
	Knife
	Green Wipe



Typical Layout FSi Pyrolastic® Silicone Sealant in 150 mm Rigid Floors and Wall Systems

Typical rigid walls seal with polyethylene backing

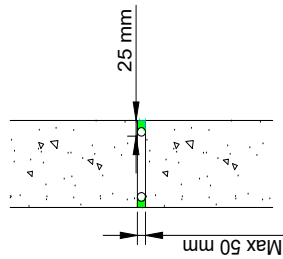

Typical hardwood and softwood rigid wall with stonewool backing

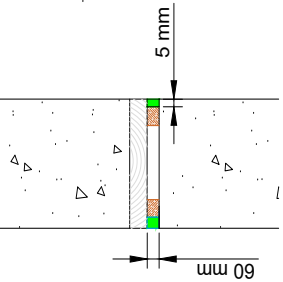

Typical hardwood and softwood rigid wall with stonewool backing

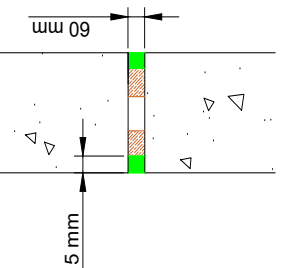

Typical rigid wall to rigid ceiling and polyethylene backing

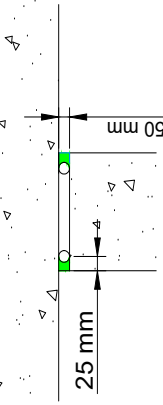

Typical rigid wall to rigid ceiling and stonewool backing

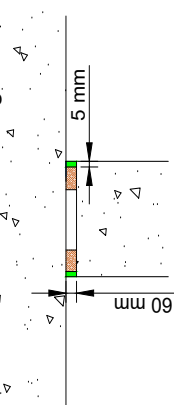

Rigid floor single seal from above with polyethylene backing

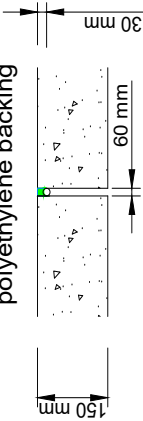

Rigid floor to wall seal from above

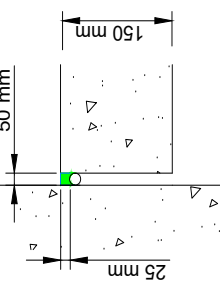

Rigid floor single seal from above with stonewool backing

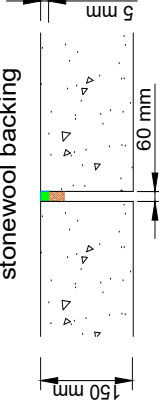

Rigid floor to steel single seal from below with stonewool backing

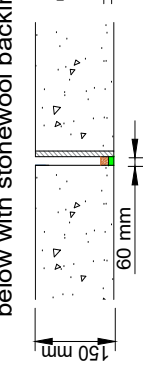

Rigid floor single seal from below with stonewool backing

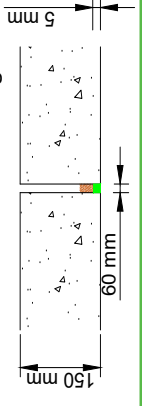

Rigid wall double seal with steel pipe with stonewool backing

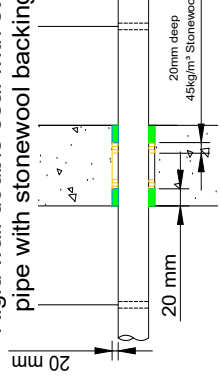

Rigid floor seal to hardwood timber from above

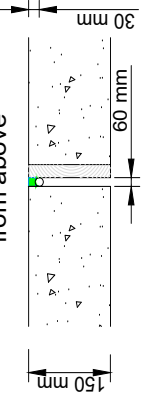

Rigid floor single seal with steel from above with polyethylene backing

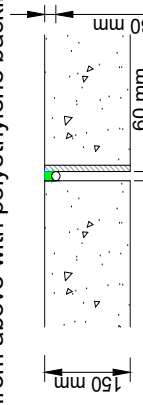

Rigid floor single seal with steel from above with stonewool backing

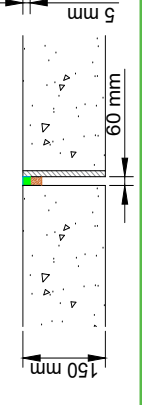

Key Installation Guidance

Maximum Linear Joint GAP size is 60mm.

FSi Pyrolastic must be installed to a minimum depth. **For stonewool backing minimum depth of Pyrolastic required is 5 mm.**

For polyethylene backing rod the depth is 2:1 width to depth ratio (Example: 50mm gap 25mm depth, 30mm gap 15mm depth)

Backing material **minimum 50mm depth** fit under compression, stonewool backing must be **minimum 45kg/m³** density.

Ensure all surfaces are clean and free from dirt and contamination before application.

Refer to Technical Data Sheet for compatibility requirements when using Pyrolastic Sealant against any substrate.

For service size limitations and parameters consult our Technical data Sheets.

Drawing Number / Name : **Typical Pyrolastic® Handbook**  
 Date : **April 2018**  
 Scale : **N/A**

The information and recommendations given herein are believed to be correct at the time of writing. Any data referred to has been obtained from tests done under laboratory, or other controlled, conditions and it is the users' responsibility to use the data given in the light of conditions on site and taking account of the intended use of the products concerned. Whilst FSI Limited can give general guidance and advice, the nature of FSI products means that the ultimate responsibility for selecting the correct product for a particular application must lie with the customer. All descriptions and illustrations in this proposal/solution are intended for guidance only and shall not constitute a 'Sale by description' picture'. All dimensions given are nominal and FSI Limited may change the information, products and specifications from time to time for a variety of reasons, without prior notice. The information in this proposal/solution is provided 'as is' at the date specified.

Flexi-Coat® is a highly flexible water based, acrylic coating used in linear gaps where voids are present in floor and wall constructions as well as service penetrations to reinstate the fire resistance performance. The Flexi-Coat® system offers excellent movement and acoustic capabilities. Flexi-Coat® can offer up to 50% movement. Flexi-Coat® can be poured, trowelled or sprayed into the aperture between the separating elements to a specified depth utilising stone wool backing material.



### Key Product Points

- Tested with Metallic Pipes, Cables, Cable Bunches, Cable Trays and Cable Ladders.
- Causes no known effects to plastic pipes, plastic cables, sheathing or metallic components.
- Joint movement capability of +/- 50% -10 to +95 °C.
- Dynamic movement testing 500 cycles per 30 minutes.
- Highly flexible and water resistant.
- Halogen free, resists fungi and vermin.
- Can be spray, brush, pour or trowel applied.
- Ideal for slab edge applications and head of wall and movement installations or where movement is expected in service penetrations.

### Certification and Approvals

- EN 1366-3, EN 1366-4
- EN 13501-2, EN 13501-1
- EN 1027, EN 1026 and EN 10140
- ASTM D2369-10, LEED 2009-EQ041 SCAQMD
- 1121-CPR-JA5010, ETA 13/1057
- UL-EU-00642, Certifire CF5094

### KEY INSTALLATION POINTS

- For good adhesion the surfaces of the building elements shall be free of any dust or grease and may need to be primed. On good, clean virgin concrete & masonry, no priming required, though refer to substrate compatibility requirements.
- Ensure that the aperture and services in question are tested with Flexi-Coat® and the site conditions are within the application specification.
- Upon installation make sure that you install the minimum 80kg/m<sup>3</sup> Stone Wool with a minimum 20% compression between substrates and or around services, ensuring a tight compression fit.
- Fit around all services effectively, brush or trowel Flexi-Coat® over the stone wool ensuring all joints and junctions are fully covered to the minimum required Flexi-Coat® thickness.
- Ensure Flexi-Coat® is overlapped onto substrates or services by minimum 20mm when coating.
- Ensure Flexi-Coat® is applied to a minimum:

**DFT (Dry Film Thickness) of 1mm (2.5mm Wet Film Thickness).**

*Stone wool minimum 80kg/m<sup>3</sup> maybe pre coated off site, applying some Flexi-Coat® to aid during installation. Ensure the correct thickness of Flexi-Coat® is applied after site installation.*

Tool Used For Installation	
	Dust pan and Brush
	Float
	Masking Tape
	Spatula
	Pencil and Ruler
	Plastic Sheet
	Tape Measure
	Paint Brush
	Spray Gun
	Green Wipe



**Typical Layout Fsi Flexi-Coat® System Rigid Walls, Floors and 100mm Flexible Wall Systems**

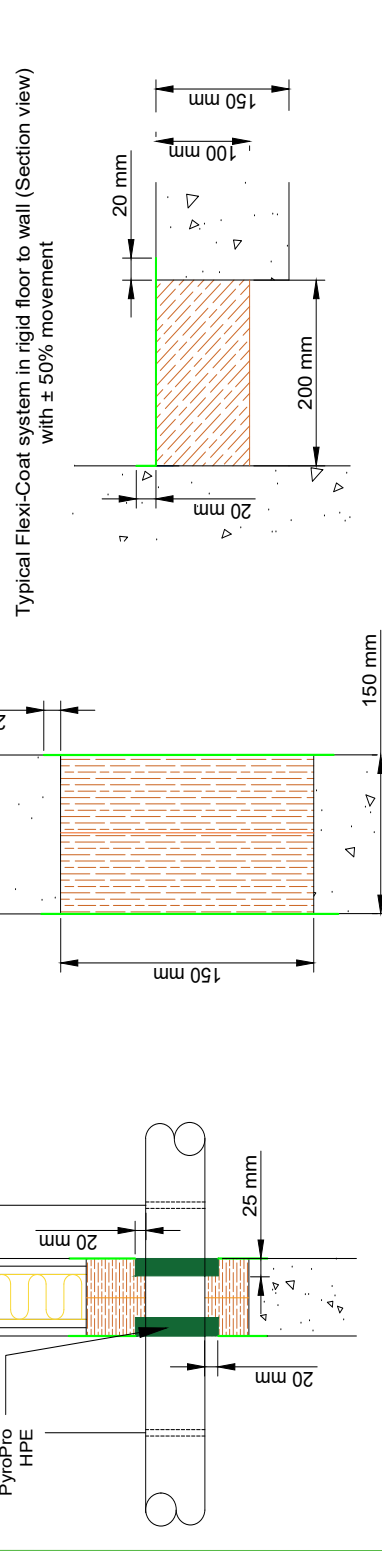
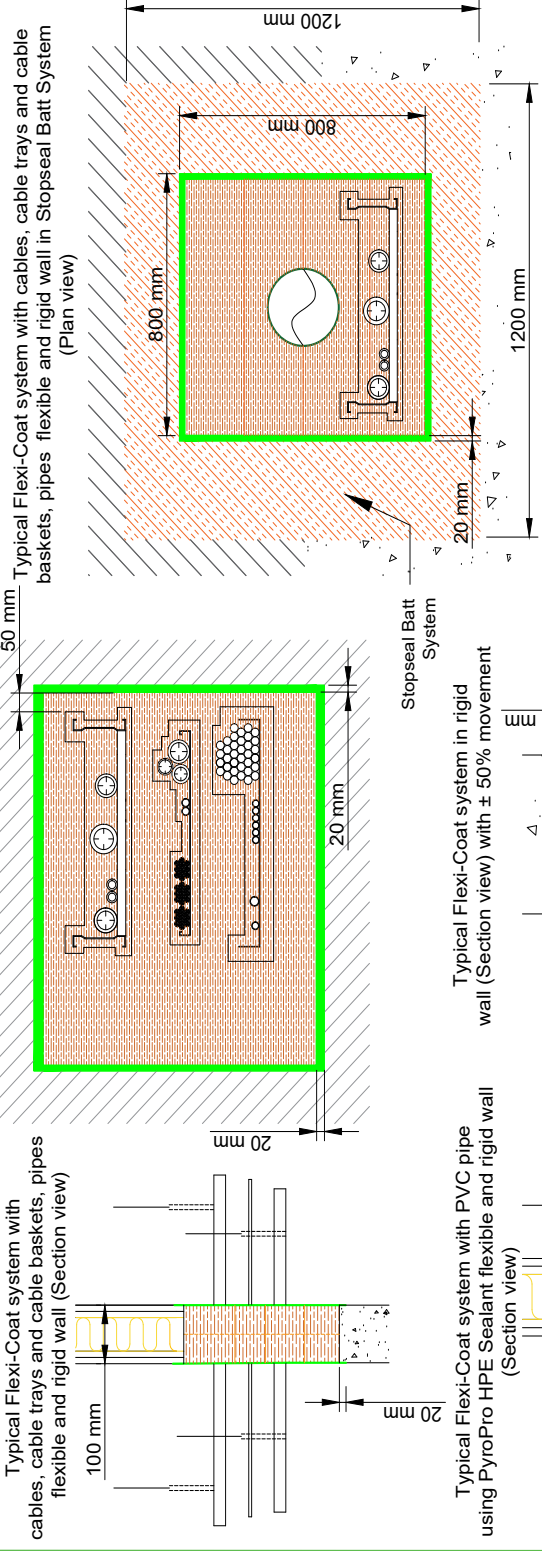

**Key Installation Guidance**

FSI Flexi-Coat system must be installed under compression using stonewool minimum **80kg/m³** **compressed minimum 20%** around all services including between cables and cable trays.

Ensure stonewool is installed in the correct orientation to allow for compression. Minimum depth of stonewool in walls and floors is **100mm deep** coated both sides of the wall using the Flexi-Coat for wall applications **ONLY**.

Services must be a minimum 50mm from the substrate edge.

Brush or trowel over the board with Flexi-Coat Sealant to a minimum DFT (Dry Film Thickness) of **1 mm** (2.5mm Wet Film Thickness).

Ensure Flexi-Coat is applied as an overlap onto all substrates minimum **20mm**.

Where Pyropro HPE is used ensure minimum **20 mm annulus** and **25mm depth both sides** of the seal as a minimum.

Refer to the Flexi-Coat Technical Data Sheet for size and service limitations and parameters for floors and walls.

Drawing Number / Name:	Typical Flexi-Coat® Handbook
Date:	April 2018
Scale:	N/A

© Copyright FSI Ltd 2018

The information and recommendations given herein are believed to be correct at the time of writing. Any data referred to has been obtained from tests done under laboratory, or other controlled, conditions and it is the users' responsibility to use the data given in the light of conditions on site and taking account of the intended use of the products concerned. Whilst FSI Limited can give general guidance and advice, the nature of FSI products means that the ultimate responsibility for selecting the correct product for a particular application must lie with the customer. All descriptions and illustrations in this proposal/solution are intended for guidance only and shall not constitute a 'Sale by description' picture'. All dimensions given are nominal and FSI Limited may change the information, products and specifications from time to time for a variety of reasons, without prior notice. The information in this proposal/solution is provided 'as is' at the date specified.

Stopseal® Ablative Spray Coating is to be used alongside the Stopseal® Batt system, to reinstate the fire resistance performance of wall constructions where they have been provided with apertures for the penetration of single or multiple services. Stopseal® Ablative Spray Coating can be applied with a brush or as a spray application.



## Key Product Points

- Can be used in flexible walls, rigid walls & floors, with Stopseal® Batts.
- Suitable for indoor use without additional environmental protection.
- Remains flexible.
- Suitable for large openings in walls and floor systems such as in combination with Stopseal® Batt.

## Certification and Approvals

- EN 1366-3, EN 13501-1 and EN 13501-2
- EN 10140, EN 1026 and EN 717-1
- BS 476 20&22
- 1121-CPR-JA5021, ETA 14/0005
- UL-EU-00771
- Certifire CF513
- BREEAM International Approved

## KEY INSTALLATION POINTS

- For good adhesion the surfaces of the building elements shall be free of any dust or grease and may need to be primed. On good, clean virgin concrete & masonry, no priming required, though refer to substrate compatibility requirements.
- Ensure that the aperture and services in question are tested with Stopseal® Ablative Spray Coating and the site conditions are within the application specification.
- Upon installation make sure that you install the minimum 140kg/m<sup>3</sup> Stone Wool.
- Fit around all services effectively, brush or trowel over the stone wool ensuring all joints and junctions are fully covered to the minimum required Stopseal® Ablative Spray Coating thickness.
- Ensure Stopseal® Ablative Spray Coating Sealant is applied to a minimum:

**DFT (Dry Film Thickness) of 1mm (2.5mm Wet Film Thickness).**

*Stone wool minimum 140kg/m<sup>3</sup> maybe pre coated off site, applying some Stopseal® Ablative Spray Coating to aid during installation. Ensure the correct thickness of Stopseal® Ablative Spray Coating is applied after site installation.*

*Refer to Stopseal® Batt for specific installation information.*

Tool Used For Installation	
	Dust pan and Brush
	Float
	Masking Tape
	Spatula
	Pencil and Ruler
	Plastic Sheet
	Tape Measure
	Brush
	Green Wipe



Stopseal® LGS Linear Gap Seal is an elastomeric foam laminated with a graphite based intumescent compound. LGS is designed to perform as a barrier in construction movement joints and long linear installations in horizontal and vertical applications. LGS allows for quick, clean installation being a pre-assembled dry product which is simply friction fitted.



## Key Product Points

- Can be used in rigid Block Wall, Concrete and Masonry.
- Can be used in rigid Concrete Floors.
- Can be used in linear joints up to 150mm wide.
- Tested with Cables, Cable Bunches, Cable Trays and Cable Trunking.
- Joint movement capability of +/- 50%.
- Highly flexible and water resistant, maintenance free, Halogen free, resists fungi and vermin.







## Certification and Approvals

- EN 1366-4, BS 476
- EN 10140, EN 1026
- Certifire CF507
- IET (IEE) 17th Edition Fire Stop Compliant to Regulation 527.1-3 - Electrical Installations.
- BS 7671-2008 Chapter 42 & 52 - Electrical Installations Fire Resistance.

## KEY INSTALLATION POINTS

- For good adhesion the surfaces of the building elements shall be free of any dust or grease and may need to be primed. On good, clean virgin concrete & masonry, no priming required.
- Ensure that the aperture and services in question are tested with Stopseal® Linear Gap Seal and the site conditions are within the application specification.
- Do not install against substrates that bleed oils, plasticizers or solvents.
- Compress seal between fingers and press into place. Slide in to place to ensure a snug fit to the surrounding building element or trunking.
- Ensure that core recovers and the edge of the seal is flush with the face of the joint.
- Stopseal® Linear Gap Seal can be cut easily with a Stanley knife to give correct fitting lengths where required.
- Joints of Stopseal® Linear Gap Seal where they butt up against each other do not require sealant just compression tight fit joints.

### Tool Used For Installation

	Dust pan and Brush
	Masking Tape
	Pencil and Ruler
	Plastic Sheet
	Tape Measure
	Knife
	Green Wipe



Typical Layout FSI LGS® (Linear Gap Seal) in Rigid Wall and Floor Systems



Typical section view LGS (Linear Gap Seal) in rigid floor system

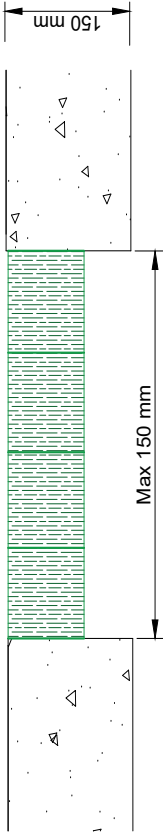

Plan view LGS (Linear Gap Seal) in rigid wall system with protected steelwork

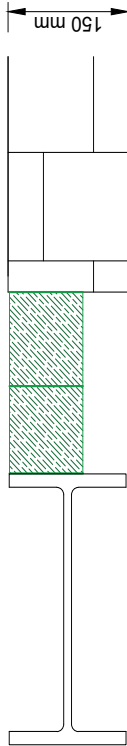

Section view LGS (Linear Gap Seal) in electrical trunking placed centrally within the aperture

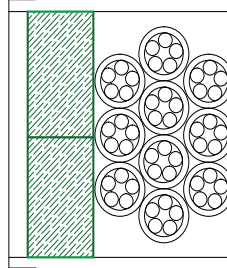

Typical section view LGS (Linear Gap Seal) at head of rigid wall and floor system

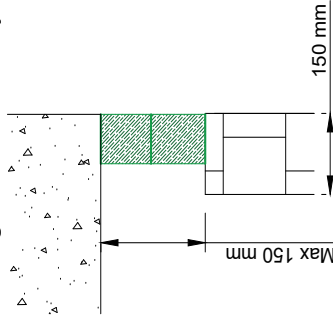

**Key Installation Guidance**

FSI LGS must be installed tightly **under compression** packed into the opening. Compress seal between fingers and press into place. Slide in to place to ensure a snug fit to the surrounding building element or trunking.

Ensure that core recovers and edge of the seal is flush with the face of the void/joint.

LGS is supplied in 1m lengths. "Butt" all lengths together where required. **No sealant** is required at joints. Ensure a tight fit.

Refer to F-Si Technical Data Sheet for size requirements in relation to gap size, limitations and parameters.

Drawing Number/ Name: **Typical LGS® Handbook**

Date: **April 2018**

Scale: **N/A**

© Copyright FSI Ltd 2018

© FSI. Please don't copy this without our consent.

The information and recommendations given herein are believed to be correct at the time of writing. Any data referred to has been obtained from tests done under laboratory, or other controlled, conditions and it is the users' responsibility to use the data given in the light of conditions on site and taking account of the intended use of the products concerned. Whilst FSI Limited can give general guidance and advice, the nature of FSI products means that the ultimate responsibility for selecting the correct product for a particular application must lie with the customer. All descriptions and illustrations in this proposal/solution are intended for guidance only and shall not constitute a 'Sale by description' picture'. All dimensions given are nominal and FSI Limited may change the information, products and specifications from time to time for a variety of reasons, without prior notice. The information in this proposal/solution is provided 'as is' at the date specified.

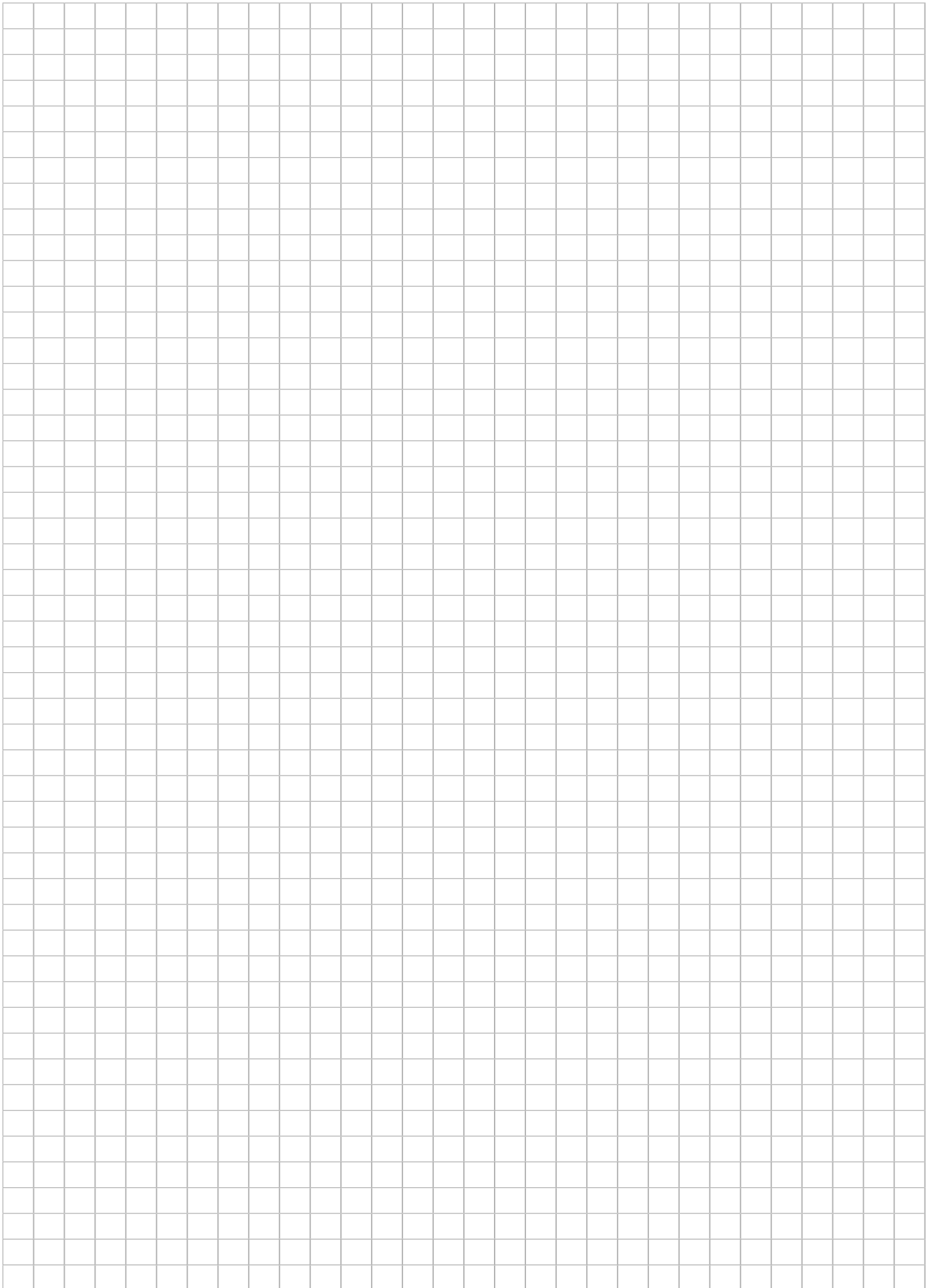

## FSi are a brand you can trust

Globally delivering Innovative Fire Stopping, Acoustic and Compartmentation Solutions.

If you feel that you would benefit from more information about the products we manufacture please feel free to visit [www.fsiltd.com](http://www.fsiltd.com), contact your local agent or FSi directly.

## FSi's Product selector APP

The FSi Ltd Fire Stopping Product Selector is a great, simple tool designed for Fire Stopping installers, distributors and inspectors to find a solution to common fire stopping installations.

The FSi Ltd Fire Stopping Product Selector, simply asks the key installation questions including:

Type of Seal, Type of wall or floor construction, Type of penetrating service, Size of opening, Type and period of fire resistance

The Product Selector guides users through these key but simple questions about the construction and penetrating services which need to be Fire Stopped. The user is then given guidance based on certified solutions using the FSi product range which are demonstrated through 2D CAD drawings, and supported by product data sheets all can be easily downloaded.

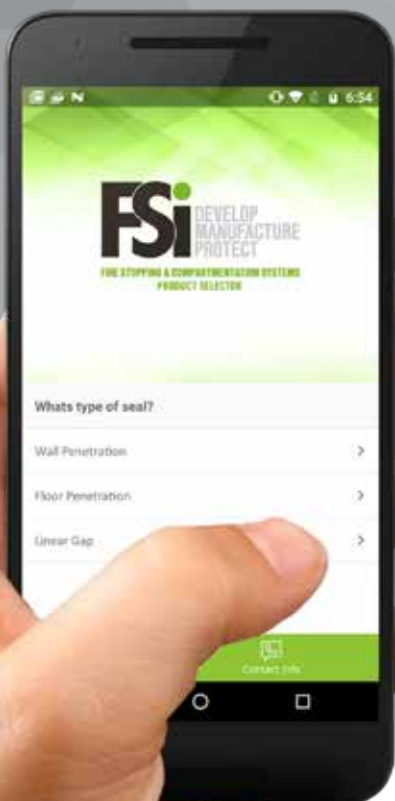

**Passive Fire Protection  
Only One Click Away**

**Download our App TODAY**

Available on the  
**App Store**

GET IT ON  
**Google Play**

"Fantastic, quick important information at my finger tips"  
- On-site User



The information and recommendations given herein are believed to be correct at the time of writing. Any data referred to has been obtained from tests done under laboratory, or other controlled, conditions and it is the users' responsibility to use the data given in the light of conditions on site and taking account of the intended use of the products concerned. Whilst FSi Limited can give general guidance and advice, the nature of FSi products means that the ultimate responsibility for selecting the correct product for a particular application must lie with the customer. All descriptions and illustrations in this proposal/solution are intended for guidance only and shall not constitute a "sale by description / picture". All dimensions given are nominal and FSi Limited may change the information, products and specifications from time to time for a variety of reasons, without prior notice. The information in this proposal/solution is provided "as is" at the date specified.

**Supplied by / Distributed by**